



A11104 411889

NIST
PUBLICATIONS**NISTIR 5461**

ORNL/Sub/83-21322/03

Abrasive Wear by Diesel Engine Coal-Fuel and Related Particles

Lewis K. Ives

Report Prepared by
U.S. DEPARTMENT OF COMMERCE
Technology Administration
National Institute of Standards
and Technology
Materials Science and Engineering Laboratory
Ceramics Division
Gaithersburg, MD 20899
under
Contract Number DE-A105-83OR21322

for

OAK RIDGE NATIONAL LABORATORY
Oak Ridge, Tennessee 37831
managed by
MARTIN MARIETTA ENERGY SYSTEMS, INC.
for the
U.S. Department of Energy
Under Contract No. DE-AC05-84OR21400

QC
100
.U56
NO.5461
1994

NIST

This report has been reproduced directly from the best available copy.

Available to DOE and DOE contractors from the Office of Scientific and Technical Information, P.O. Box 62, Oak Ridge, TN 37831; prices available from (615) 576-8401, FTS 626-8401.

Available to the public from the National Technical Information Service, U.S. Department of Commerce, 5285 Port Royal Rd.,-Springfield, VA 22161.

This report was prepared as an account of work sponsored by an agency of the United States Government. Neither the United States Government nor any agency thereof, nor any of their employees, makes any warranty, expressed or implied, or assumes any legal liability or responsibility for the accuracy, completeness, or usefulness of any information, apparatus, product, or process disclosed, or represents that its use would not infringe privately owned rights. Reference herein to any specific commercial product, process, or service by trade name, trademark, manufacturer, or otherwise, does not necessarily constitute or imply its endorsement, recommendation, or favoring by the United States Government or any agency thereof. The views and opinions of authors expressed herein do not necessarily state or reflect those of the United States Government or any agency thereof.

Abrasive Wear by Diesel Engine Coal-Fuel and Related Particles

Lewis K. Ives

Report Prepared by
U.S. DEPARTMENT OF COMMERCE
Technology Administration
National Institute of Standards
and Technology
Materials Science and Engineering Laboratory
Ceramics Division
Gaithersburg, MD 20899
under
Contract Number DE-A105-83OR21322

for

OAK RIDGE NATIONAL LABORATORY
Oak Ridge, Tennessee 37831
managed by
MARTIN MARIETTA ENERGY SYSTEMS, INC.
for the
U.S. Department of Energy
Under Contract No. DE-AC05-84OR21400

September 1994



U.S. DEPARTMENT OF COMMERCE
Ronald H. Brown, Secretary
TECHNOLOGY ADMINISTRATION
Mary L. Good, Under Secretary for Technology
NATIONAL INSTITUTE OF STANDARDS
AND TECHNOLOGY
Arati Prabhakar, Director

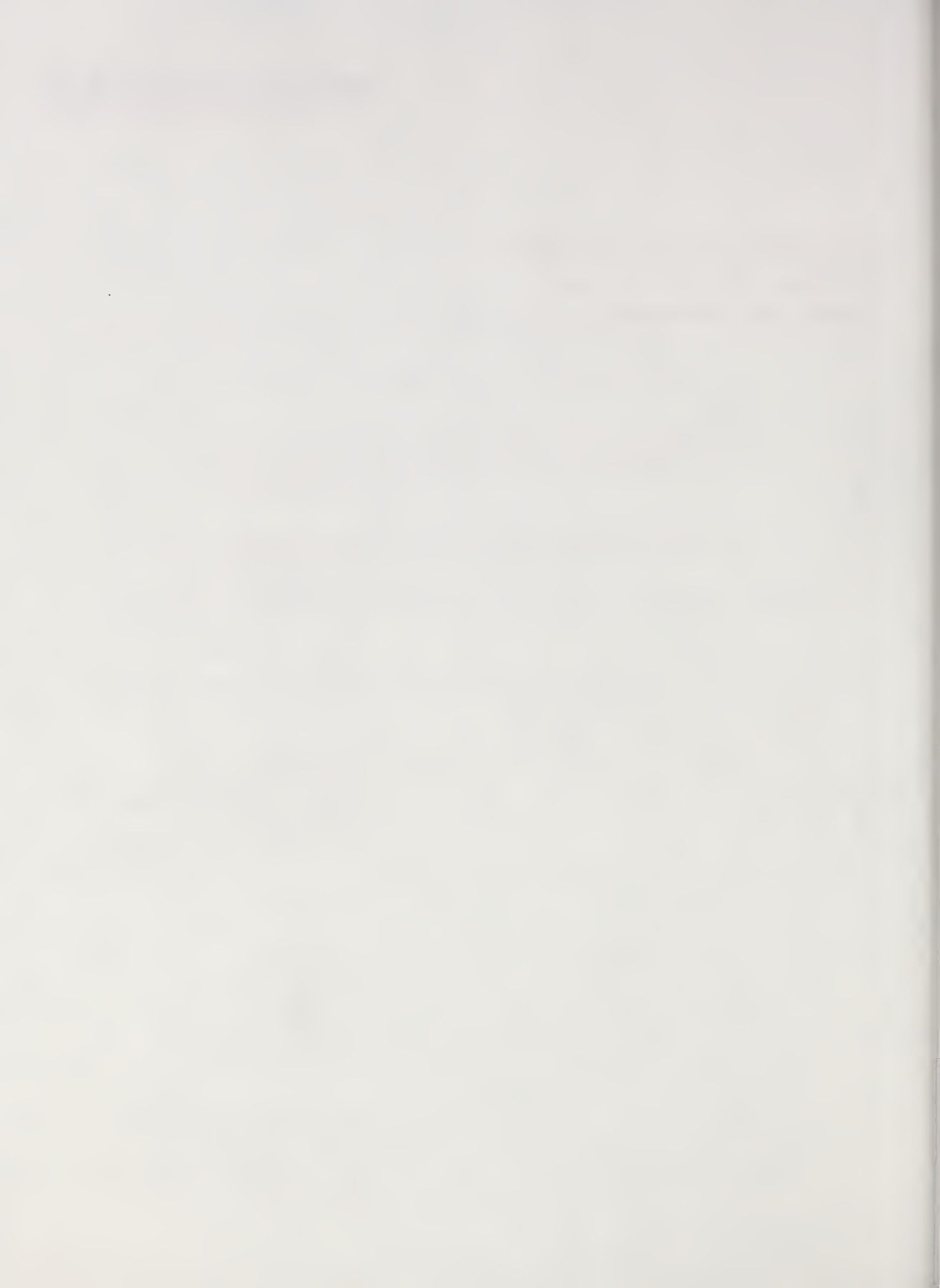

ABSTRACT

The purpose of the work summarized in this report was to obtain a basic understanding of the factors which are responsible for wear of the piston ring and cylinder wall surfaces in diesel engines utilizing coal-fuel. The approach included analytical studies using scanning electron microscopy and energy dispersive x-ray analyses to characterize coal-fuel and various combustion particles, and two different wear tests. The wear tests were a modified pin-on-disk test and a block-on-ring test capable of either unidirectional or reciprocating-rotational sliding. The wear tests in general were conducted with mixtures of the particles and lubricating oil. The particles studied included coal-fuel, particles resulting from the combustion of coal fuel, mineral matter extracted during the processing of coal, and several other common abrasive particle types among which quartz was the most extensively examined. The variables studied included those associated with the particles, such as particle type, size, and hardness; variables related to contact conditions and the surrounding environment; and variables related to the type and properties of the test specimen materials.

"Research sponsored by the U.S. Department of Energy, Fossil Energy Advanced Research and Technology Development Materials Program, DOE/FE AA 15 10 10 0, Work Breakdown Structure Element NIST-3"

TABLE OF CONTENTS

	Page
ABSTRACT.....	v
TABLE OF CONTENTS.....	vii
1. INTRODUCTION.....	1
2. EXPERIMENTAL PROCEDURE	3
2.1 Pin-On-Disk Test	3
2.2 Block-On-Ring Test	7
2.3 Particulate Materials	11
3. RESULTS AND DISCUSSION	18
3.1 Pin-On-Disk Tests	18
3.1.1 Sliding Distance	18
3.1.2 Particle Concentration	19
3.1.3 Quantity of Mixture	23
3.1.4 Particle Hardness	24
3.1.5 Particle Size	26
3.1.6 Particle Embedment	28
3.1.7 Relative Humidity	30
3.1.8 Oil Additives	32
3.1.9 Different Coal-Related Particles	33
3.1.10 Wear of Selected Materials	35
3.1.11 Wear of WC-6Co	40
3.2 Block-On-Ring Tests	43
4. SUMMARY AND CONCLUSIONS	51
5. ACKNOWLEDGEMENTS	54
6. REFERENCES	54
Distribution	59

1. INTRODUCTION

This report summarizes the results of a research program aimed at developing a basic understanding of the various factors which are responsible for wear in diesel engines that directly utilize pulverized coal as a primary fuel. The investigation was limited to the treatment of sliding wear, although solid particle erosive wear is also recognized to be a serious problem. Most of the results have been presented earlier in a series of semiannual reports [1-5], conference proceedings [6-8], and in an interim summary report [9]. This report highlights the important findings and conclusions. In most cases much greater detail can be found in the above references. In particular, a rather complete description of the work, except for the final phase of the program, is included in the interim summary report [9].

Because of its great abundance and relatively high energy density, coal, it would seem, should offer a significant potential as a fuel for internal combustion engines. Indeed, Rudolf Diesel over 100 years ago at the time of his invention of the engine known by his name had demonstrated that powdered coal could be used as a fuel. With considerable reserves of coal and only a limited internal supply of oil, extensive research and experimentation was conducted in Germany to develop coal-fueled diesel engines. The effort was most intense in those years leading into the First World War and again in the period just before and during the Second World War. Although several engines were built and operated by the time the effort was terminated towards the end of the Second World War, the development was not sufficiently successful to warrant manufacture of an engine on a production basis. A major limiting factor was the high rate of wear experienced by engines operated on coal. Difficulties were also encountered in adequately controlling the introduction of the dry coal powder employed as a fuel.

Motivated also by limited internal oil resources as well as the oil embargo of 1973 and encouraged by abundant supplies of coal, the US Department of Energy

began to explore the direct use of pulverized coal as a fuel both for turbine engines and diesel engines. Although conversion of coal to liquid or gaseous fuels was certainly an important alternative, on the basis of energy efficiency, direct combustion of coal was a compelling approach. Utilization of coal as a fuel was stimulated further by the development of low-ash-content coal-water slurries which could be injected directly into the engine combustion chamber in much the same way as conventional oil fuel.

With support from the DOE, laboratory studies were carried out to establish the combustion characteristics of coal-water slurries [10]. More directly, Nydick, Porchet, and Steiger [11] conducted an extensive investigation to evaluate the actual performance of coal-water slurry fuels in a diesel engine. For this purpose, a large, low-speed, experimental, single cylinder diesel engine was modified to operate on coal-fuel. Changes were made in the injection system to accommodate the coal-water slurry fuels. A pilot injection system for No. 2 diesel oil fuel was also incorporated to provide a means for initiating the combustion of coal-fuel on each cycle. In other respects the engine differed little from a conventional oil-fuel operated configuration. In particular, the standard grey cast iron piston ring and cylinder liner components were retained. Test runs were conducted on four different coal-fuels distinguished by different particle sizes, ash contents and ash compositions. Because of the exceedingly high wear rate, the maximum operating life of the engine was limited to only a few hours of operation. Wear rates of the piston rings ranged from 56 to 160 times greater than usually experienced during operation on No. 2 diesel oil fuel. Similarly, cylinder liner wear rates ranged from 13 to 42 times greater than normally experienced with No. 2 diesel oil fuel. Based on their examination of the ring and liner surfaces, Nydick et al. concluded that adhesive wear in addition to abrasive wear had occurred.

Included in the DOE program to promote the development of coal-fueled engines were a project at Adiabatics Inc. to demonstrate the operation of a low-heat-rejection engine [12], a joint project between A. D. Little Co. and Cooper-Bessemer [13] to develop large stationary engines, and a project at General Electric Corporation

[14] to develop a locomotive engine. Each of these efforts placed strong emphasis on the reduction of wear, recognizing that without suitable engine durability a viable and commercially acceptable engine was out of the question. In general, the approach taken to control wear emphasized the utilization of wear resistant materials and coatings. Consideration was also given to reducing wear by improvement in component design. In this connection, research was sponsored at Southwest Research Institute with the intention of designing piston rings to reduce wear [15].

In the investigation carried out at NIST and summarized here, relatively simple bench tests and laboratory based analyses, rather than difficult and expensive engine tests, were employed to study wear processes associated with the use of pulverized coal as a diesel engine fuel. The program had three objectives: 1) to determine the effects of particle characteristics and test-related variables on wear rate, 2) to investigate the influence of various materials properties on wear rate, and 3) to determine the influence of the type of sliding motion and contact geometry on wear rate.

2. EXPERIMENTAL PROCEDURE

2.1 Pin-On-Disk Test

Sliding wear tests were conducted utilizing mineral oil mixed with a number of different types of particles. For experiments that were designed to determine the influence of particle characteristics, contact variables, and materials properties (objectives 1 and 2, above) a pin-on-disk test device was used. The design of the test device differed from the conventional pin-on-disk configuration. In the conventional pin-on-disk arrangement, one component rotates while the other is stationary. That is, the pin is held stationary and the disk rotates or, less often, the disk is held stationary and the pin revolves about the center of the disk. In either case a circular track is produced on the disk. In the design utilized in this investigation, the pin and the disk

both rotate by means of separate but parallel shafts. The configuration is illustrated schematically in Fig. 1. The shaft axes are offset by 2.54 cm and are driven through a gear train so that their rotation is in the same direction but at slightly different speeds. As a result the pin follows a crisscrossing spiral path on the disk. A computed plot of the path is shown in Fig. 2. For clarity, only 2/3 of a complete cycle is shown. At the pin:disk rotation ratio used (41:43), a complete cycle requires 43 revolutions of the disk. Because of the difference in pin and disk rotational speeds the speed at which the pin moves relative to the disk oscillates by $\pm 2.3\%$ about the average value. In addition, the pin rather than maintaining a fixed position with respect to its path on the disk, rotates about its axis perpendicular to the disk. Thus, the direction of sliding against the pin, rather than being unidirectional as it is in the conventional pin-on-disk design varies continuously.

Among the advantages of this design is the significant increase in path length on the disk. For a given sliding distance this results in shallower groove on the disk and a correspondingly flatter scar on the pin. Even when the abrasion conditions are only moderately severe, a relatively deep groove can be worn rapidly in the disk with the conventional pin-on-disk design. This results in a more difficult to measure curved scar on the pin. Moreover, frequent refinishing of the disk is required. With the design used here, a large number of tests, or equivalently a long sliding distance could be accommodated before it was necessary to refinish the disk surface. Another benefit of the dual rotating motion was the mixing action on the oil-particle mixture, preventing particle settling and maintaining constant flow of mixture into the contact. However, it was still necessary to employ a baffle, shown in Fig. 1, to direct the flow of the mixture to the center of the disk from its outer circumference.

Perhaps the most important advantage of the design was the capability to utilize the three-pin configuration shown in Fig. 1b. This arrangement made it possible to compare the response of three different pin materials under essentially identical conditions, or alternatively, to obtain three measurements on the same material in a single test.

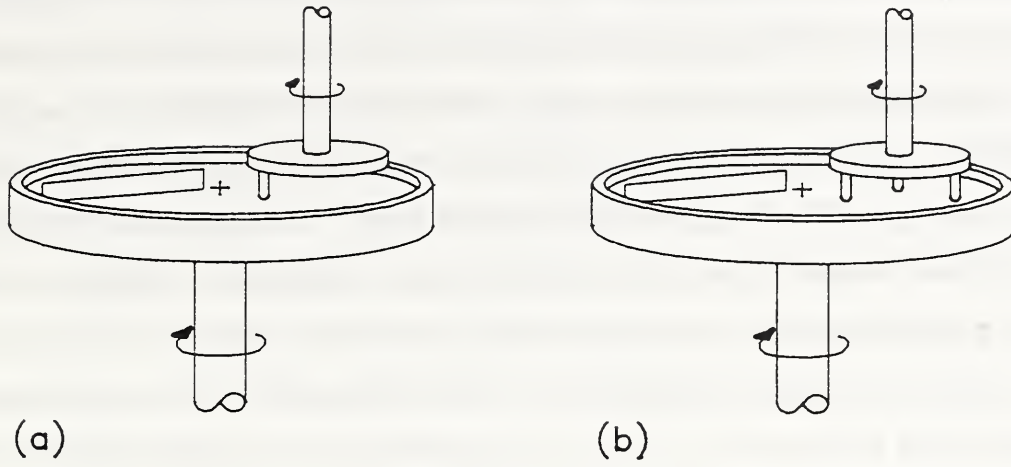

Fig. 1. Rotating pin-on-disk test configurations (a) single pin, (b) 3-pin.

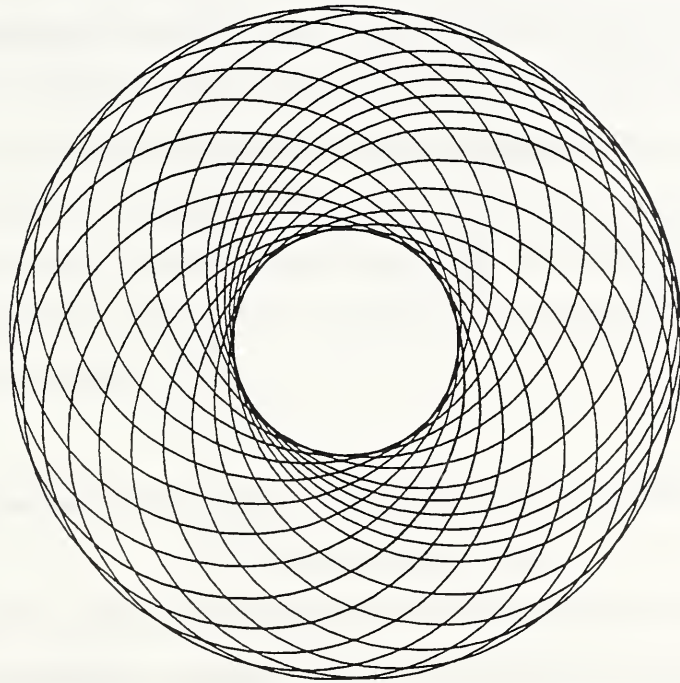

Fig. 2. Computed path traced out by pin on disk surface.

Unfortunately, the rotating pin-on-disk design also has some deficiencies. Among these are the difficulty or infeasibility in most cases of measuring disk wear because of the relatively small track depth. Also, measurement of the coefficient of friction is complicated by the fact that both pin and disk rotate and there is a continuous change in the direction of the friction force. The coefficient of friction was not measured in these experiments, although other designs with both pin and disk rotating have been instrumented for the measurement of coefficient of friction.

Two different pin geometries (Fig. 3) were employed in the experiments. For the majority of the experiments 9.525 mm diameter balls were used, Fig. 3a. When materials were not available in the form of balls, pins were prepared in the shape of a cylinder with a conical tip shown in Fig. 3b. The conical tipped pins were used with a preworn flat. Flats were also preworn on spherical pins for some experiments to avoid the initially high stresses associated with a sphere on flat contact.

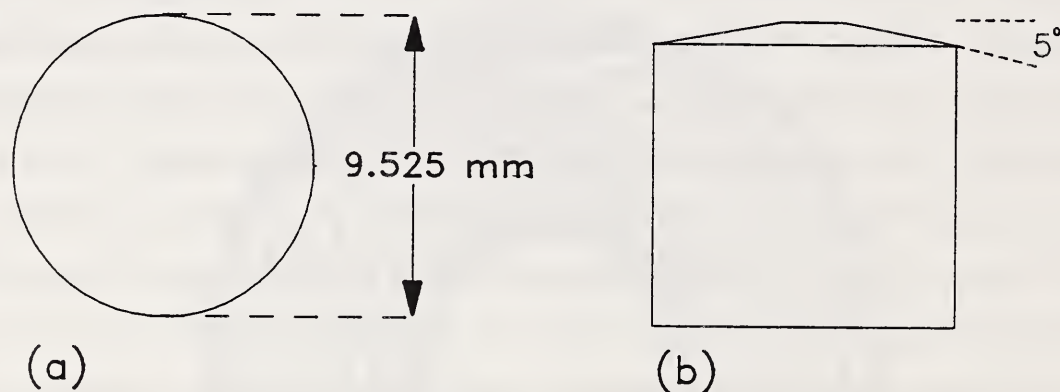

Fig. 3. Spherical and conical pins used in pin-on-disk tests.

Pin wear volume was calculated from measured values of the pin scar diameter. The scars were nominally flat, so the volume calculation was based on a simple planar section through a sphere or cone as required by the pin geometry. The scar diameter was measured by means of an optical microscope equipped with a calibrated eyepiece scale.

Disks of two different materials were employed for the pin-on-disk tests. Initial studies were conducted with disks of AISI O2 tool steel heat treated to a hardness of 730 HK_{0.2N}. The majority of the experiments, however, were conducted with 52100 steel disks, also heat treated, but to a hardness of 810 HK_{0.2N}. Hard carbide precipitates in both materials resulted in two-body abrasive wear of the pin with the effect being slightly greater for O-2 tool steel. However, for both materials this "background" wear rate was relatively small compared to that generated with most of the oil-particle slurries. The disk surface was finished by lapping on 6 μm diamond grit with mineral spirits as a lubricant.

The majority of the experiments performed to investigate the effects of particle parameters and contact conditions were carried out with 52100 steel bearing balls. In addition, to satisfy the goal of objective 2, a variety of different pin materials was studied. A list of the pin materials is given in Table 1. A brief description of the material, whether the pin was in the form of a ball or cone, and the Knoop hardness of the material measured at a load of 0.2 N are included in the table.

Typical conditions for experiments carried out with the rotating pin-on-disk device are given in Table 2. The relative humidity of the air environment was measured but not controlled. In general, the relative humidity was higher during summer months than in the winter, although daily weather conditions had a substantial influence. With the loads, speeds, and contact geometry used, sliding took place in the boundary lubrication regime. Thus, even in the absence of abrasive particles wear of the pin and disk occurred.

2.2 Block-On-Ring Test

The pin-on-disk test provided a useful and simple means of studying the influence on wear rate of a number of test parameters. Despite significant differences in contact geometry, sliding motion, and lubrication regime at the ring-liner contact in a

Table 1. Pin Materials

<u>Material</u>	<u>Description</u> *	<u>Hardness</u> (HK _{0.2N})
Ta	(C) 99.5% pure	174
Mo	(C) 99.5% pure	267
Ni	(C) 99% pure	294
W	(C) 99.98% pure	496
316 stainless	(B) annealed	253
K-Monel	(B) age hardened	426
52100 steel	(B) ball bearing	800
440C steel	(B) ball bearing	834
M50 steel	(B) ball bearing	780
Black Glass	(B) 69.7% SiO ₂ ; 3.4% CaO; 3.2% BaO; 15.2% Na ₂ O; 0.8% K ₂ O; 1.3% B ₂ O ₃ ; 6.4% MnO ₂	469
Fused Quartz	(C) -	590
Zirconia	(C) Sintered TZP	1090
Silicon Nitride	(B) Toshiba	1650
WC-6Co	(B) Carboloy 44A	1660
Sapphire	(B) -	1780

* (B) - Ball and (C) - Conical Pin

Table 2. Pin-On-Disk Test Conditions

Disk material -- AISI O2 tool steel (730 HK_{0.2N})
 AISI 52100 steel (810 HK_{0.2N})

Pin material -- AISI 52100 steel bearing ball (820 HK_{0.2N})

Load per pin -- 15 N

Speed -- 60-63 cm/s

Atmosphere -- Air, Relative Humidity ~20 - 65%

Temperature -- 23±2°C

Oil -- Paraffinic mineral oil (335-365 SUS @ 37.8°C)

Oil+Particle charge per test -- 2 ml

diesel engine, the relative response is expected to be similar for a number of test parameters. For example, the relative influence of particle hardness on wear rate is probably similar for the two different tribological contacts, as long as the same pair of sliding materials are utilized, that is, the pin and disk are of the same materials as the ring and liner. Certain other parameters may not be adequately evaluated by the pin-on-disk configuration. In order to investigate this possibility (objective 3), tests were conducted with a block-on-ring configuration (Falex #1* block-on-ring wear test machine) operated both in a unidirectional rotational mode and in a bidirectional oscillating mode. Both the block and the ring were of 52100 steel heat treated to a hardness of 710 HK. Two specimen sizes are available for the Falex test machine. The Falex or LFW1 size and the Timken size. The Falex size (34.99 mm outside diameter by 8.74 mm wide)[16] was used in these experiments. The initial surface roughness of the block and ring specimens was approximately 0.2 μm rms. Only the block was used in the determination of wear rates. As with the disk in pin-on-disk tests, the relatively small volume of wear associated with these tests and the fact that the wear was distributed over a large area made measurement of ring wear difficult and of poor accuracy at best. Determination of scar volume on the block was derived from profilometer traces across the scar. The average scar cross sectional area was determined from five equally spaced traces across the scar. The volume was given by the product of the area and scar length (equivalent to the block width).

For unidirectional motion, the spindle to which the ring was mounted was driven directly through a belt and pulleys by a variable speed dc motor. To achieve oscillating motion, the belt and pulleys were replaced by a connecting rod and eccentric couplings attached to the motor shaft and spindle. The amount of eccentricity was adjustable allowing the amplitude of oscillation to be selected within a range extending from nearly 0 to 90 degrees. The system was not counter-balanced

*Certain trade names and company products are identified in order to adequately specify the experimental procedure. In no case does such identification imply recommendation or endorsement by the National Institute of Standards and Technology, nor does it imply that these products are necessarily the best available for the purpose.

so the maximum frequency of oscillation was limited to no more than 200 cycles per minute. The basic conditions employed for the block-on-ring tests are summarized in Table 3. As with the pin-on-disk test, the relative humidity was measured but not controlled.

Table 3. Block-On-Ring Test Conditions

Load	225 N
Unidirectional Sliding Speed	0.16 m/s
Oscillating Amplitude	90 degrees
Oscillating Frequency	172 Hz
Sliding Distance	495 m
Fluid Delivery Rate	10 mg/min.
Atmosphere	Air, 50% relative humidity
Ambient Temperature	23±2 °C

The oil-particle mixture, or oil without particles used for some reference tests, was supplied to one end of the contact between the block and ring by means of a nozzle. A schematic drawing of the fluid delivery system is shown in Fig. 4. As indicated, the fluid was drawn from a reservoir and supplied to the nozzle by means of a variable-speed tubing pump. The fluid reservoir was stirred continuously to prevent settling of the particles.

A scraper blade made from 0.13 mm thick cellulose acetate film was pressed against the surface of the ring at the end of the contact opposite the delivery nozzle to collect oil, abrasive particles, and wear debris that passed through the contact. The scraper blade was approximately 3 mm wide, about one half the width of the block. In this way only oil and particles that emerged from the contact were subject to collection, and fluid that passed along the sides of the block was avoided. The collected particles and debris were examined by means of scanning electron microscopy to reveal their size and shape. Compositional analyses were carried out in the SEM by means of energy dispersive x-ray spectroscopy (EDS).

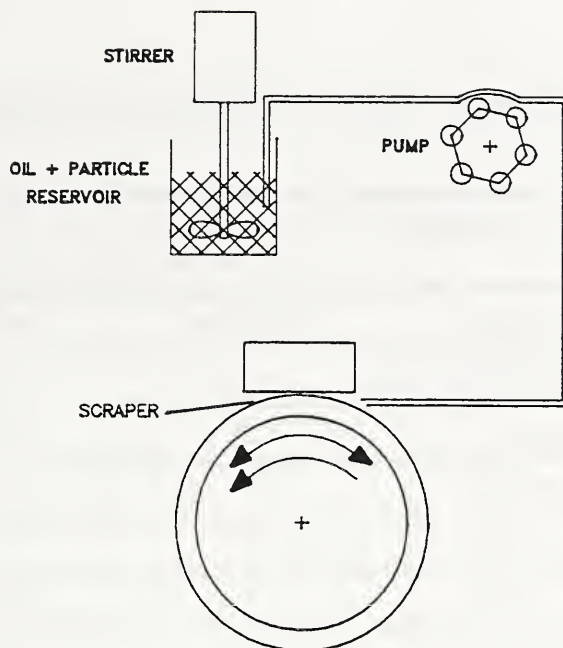

Fig. 4. Schematic drawing of the block-on-ring test setup.

2.3 Particulate Materials

Considerable attention was focussed on evaluating the effects of coal-related particulate materials on wear rate. However, since these materials were, in general, complex mixtures of different particle types, sizes, and shapes, evaluation of the influence of specific particle characteristics could not be carried out directly from such mixtures. Therefore, several different well-characterized particulate materials (quartz, aluminum oxide, magnesium oxide, and diamond) were included in the investigation. A list of the particulate materials studied, together with some of their important properties, is given in Table 4.

The coal-fuel related materials consisted of unburned Otisca Blue Gem coal-fuel particles, mineral matter extracted in preparation of the coal-fuel, and two materials derived from the combustion of coal-fuel. The latter two materials were, in one case, exhaust particles collected during tests on an experimental gas turbine combustor; these are referred to as combustor particles. In the other case, the

Table 4. Particulate Materials Used in Wear Tests

MATERIAL	SIZE (μm)	HARDNESS (kg/mm^2)
Otisca Blue Gem Coal-fuel	4	34
Mineral Matter Extracted from Coal	4	1000 max.
GE Combustor Particles	5	1000 max.
Diesel Engine Filter Residue	3	1000 max.
GE Aluminum Oxide	2	2100
Aluminum Oxide	1	2100
Aluminum Oxide	3	2100
Magnesium Oxide	2	700
Min-U-Sil (R)5 (quartz)	2	1000 max.
Quartz BCR #66	1	800-1000
Quartz BCR #70	3	800-1000
Quartz BCR #67	10	800-1000
Diamond	1	10,000

particles were removed from the centrifugal filter of an experimental coal-fueled diesel engine and are referred to as filter residue particles. Both particulate materials were supplied by the General Electric Corporation and were generated from the combustion of Otisca Blue Gem coal-fuel.

Otisca Blue Gem coal-fuel is a product of Otisca Industries. It is prepared from a low ash content, eastern bituminous coal-- Kentucky Blue Gem coal. The Kentucky Blue Gem feed coal has an ash content of approximately 2%. Beneficiation involves comminution and fluid agglomeration to separate the coal from mineral matter [17]. After processing the ash content is less than 1%. The coal-fuel itself is supplied as an approximately 50% mixture of coal particles and water. Table 5 lists the principle mineral species present together with their concentrations in the feed coal and in the

Table 5. Mineral Concentrations in Otisca Blue Gem Low-Temperature Ash and Coal Samples (adapted from [18])

Mineral	Weight Percent of Mineral in Low-Temperature Ash		Mineral Content on Dry Coal Basis (Wt.%)	
	Raw Coal	Product Coal	Raw Coal	Product Coal
α -Quartz	1.7	0.9	0.070	0.009
Kaolinite	12.2	12.3	0.288	0.119
Anhydrite	1.4	5.9	0.033	0.057
Calcite	3.3	1.2	0.078	0.012
Pyrite	19.8	1.1	0.467	0.011
Ferric Sulfate	9.5	13.1	0.224	0.127
Total:	47.9	34.5		

coal-fuel [18]. These results were obtained by x-ray diffraction analyses of low temperature ash. Low temperature ashing concentrates the mineral matter while minimizing thermal and oxidative induced changes in the mineral species. It may be noted that less than one half of the total mass of the ash is accounted for in Table 5. The unaccounted for material was attributed to amorphous constituents, crystalline species at a concentration too low to be detected, unidentified crystalline species, and residual carbonaceous material that was not burned in the ashing process [18].

Table 5 indicates that processing has resulted in a considerable reduction in the concentration of both quartz and pyrite. This is significant because these are the hardest minerals present and therefore of greatest concern with respect to abrasive wear. Quartz, on the Mohs scale, has a hardness of 7 while pyrite is slightly softer with a value of 6 - 6.5. The remaining minerals have hardness values less than 3.5 and are not likely to contribute significantly to abrasive wear of materials suitable for use in the coal-fueled diesel engine which necessarily must be harder than quartz. The soft particles may, however, result in polishing wear, generally a much milder form of wear. On the other hand, exposure to high temperature, high pressure

combustion conditions results in the formation of ash particles from the various mineral matter constituents in the coal. The ash particles, although harder than the soft clay particles, are still not as hard as quartz.

Samples of coal-fuel particles were examined in the SEM. A typical collection of particles is shown in Fig. 5. Energy dispersive x-ray analysis of numerous particles did not reveal any that were composed entirely of mineral elements without the presence of carbon from coal [8,9]. This is not too surprising since at a concentration of 1% only about one in one hundred particles could be a mineral matter particle. However, the fact that particles that were primarily carbonaceous frequently displayed elements in their spectra such as silicon, aluminum, iron, and sulfur—elements which are commonly found in mineral matter—indicated that most of the mineral matter was contained in the coal particles. This finding is consistent with the fact that the processing method, by design, was a very efficient means of removing free mineral matter particles [17]. A consequence of this characteristic of the coal-fuel is that the mineral matter particles present very likely had a smaller average particle size than the overall average particle size of the coal-fuel.

The concentration of constituents in extracted mineral matter material that was employed in wear tests is represented by the difference between the mineral content of the feed coal and the product coal in Table 5. Accordingly, the hard minerals quartz and pyrite will be present in relatively high concentrations. A scanning electron micrograph of these particles is shown in Fig. 6.

The combustor and engine filter residue materials were found to consist of four different particle types: unburned coal particles; partly burned porous particles, usually with a relatively high mineral element content; spherical ash particles comprised almost entirely of mineral elements; and soot particles. The first three of these particle types can be seen in Fig. 7a. Soot particles, because of their small size, were not resolved at the magnification employed for Fig. 7a and are shown clinging to a spherical particle in Fig. 7b. Small quantities of particles collected from the exhaust of experimental diesel engines operating on coal-fuel were also examined in the SEM. The same four particle types were also found to be present in these samples,

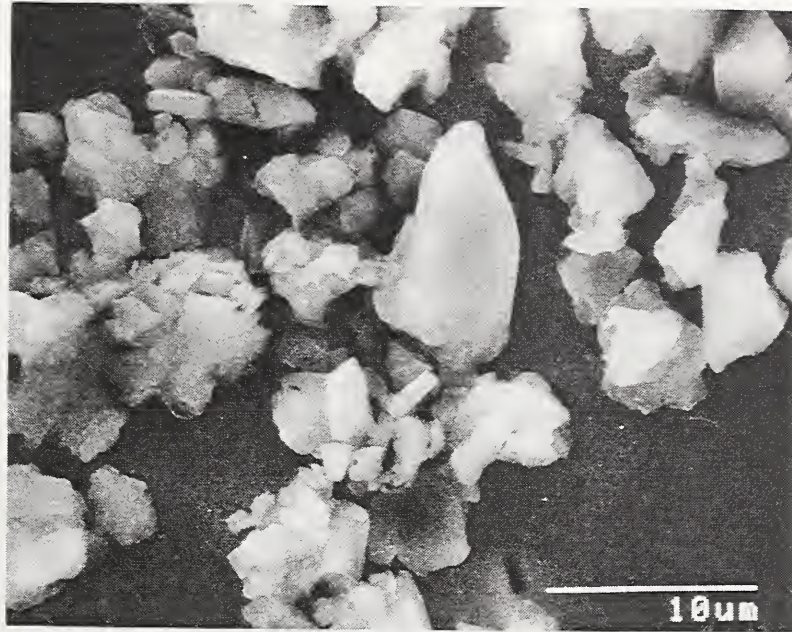

Fig. 5. SEM micrograph of Otisca Blue Gem coal-fuel particles.

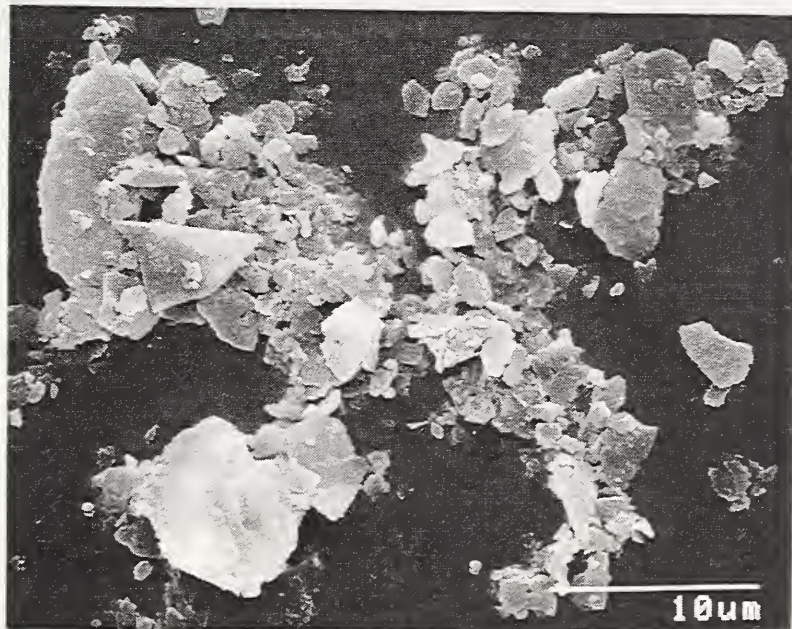
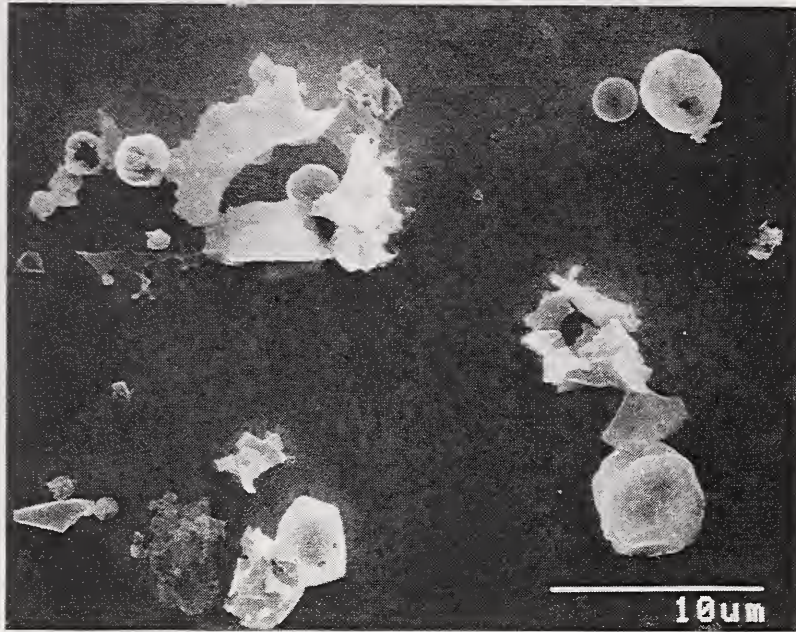

Fig. 6. SEM micrograph of mineral matter particles extracted during processing Blue Gem coal-fuel.

(a)



(b)

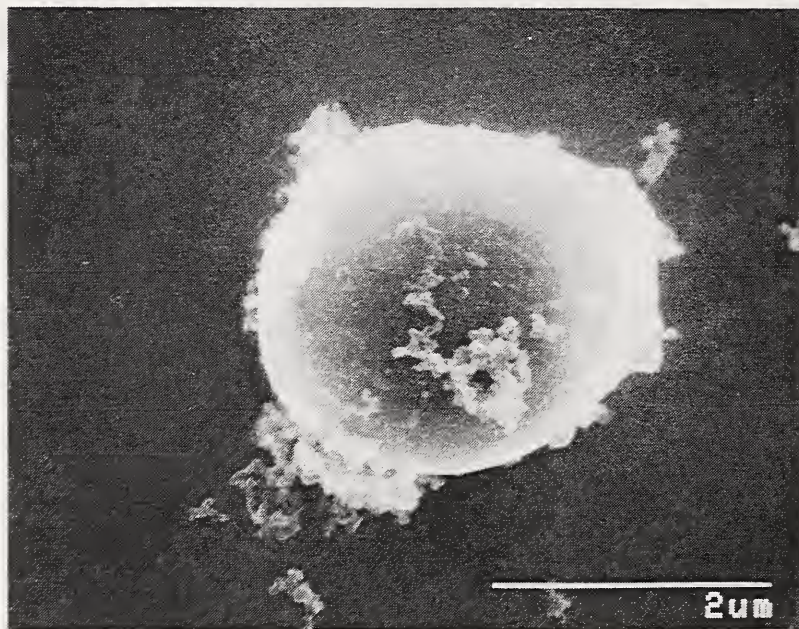

Fig. 7. (a) SEM micrograph of combustor particles. (b) Spherical combustor particle.

providing additional verification of the nature of the particles that are likely to be present at the piston ring / cylinder wall contact. The concentration of each particle type will of course be a function of the operating conditions of the engine.

Among the remaining particles listed in Table 4, the aluminum oxide, magnesium oxide, and diamond particles were materials that are ordinarily used for polishing and lapping purposes. As is desirable for such applications, the size distributions of these particles were narrowly distributed about the designated average size values. The GE aluminum oxide particles were obtained from General Electric Corporation and were from a supply of material that had been used by Mehan [19] for studies related to wear in the coal-fueled diesel engine. The three different quartz particulates designated BCR were certified standard reference materials prepared for use in the calibration of particle size measurement instruments through the auspices of the Commission of the European Communities Community Bureau of Reference. The particle size distributions have been accurately and precisely determined. These particles were employed mainly to investigate the influence of particle size on wear rate. Extensive application of these particles was limited by their high cost. In other experiments utilizing quartz particles the Min-U-Sil(R)5 particles were employed. These particles were readily available at low cost, and their average size of $\sim 2 \mu\text{m}$ is approximately equal to the size that quartz particles might have in the coal-fuel.

3. RESULTS AND DISCUSSION

3.1 Pin-On-Disk Tests

The effects on wear rate of the following parameters were investigated:

- sliding distance
- particle concentration
- quantity of mixture
- particle hardness
- particle size
- particle embedment
- relative humidity
- oil additives
- type of coal-related particle
- abrasion resistance of materials

Clearly, the number of parameters is large, and within the scope of the program, it was not possible to investigate the complete functional dependence of any one parameter with respect to all other relevant parameters. Indeed, a number of parameters in addition to those listed could also have been included in the program. For example, test temperatures other than room temperature could have been studied, as could environments other than air, a greater variety of disk materials, and different lubricants and additives. To have included these would have required a far more extensive program than was carried out here. In the following sections results obtained for each of the parameters listed will be summarized briefly.

3.1.1 Sliding Distance

Pin wear volume is plotted as a function of sliding distance in Fig. 8 for combustor particle concentrations ranging from 0% to 20%. The straight lines

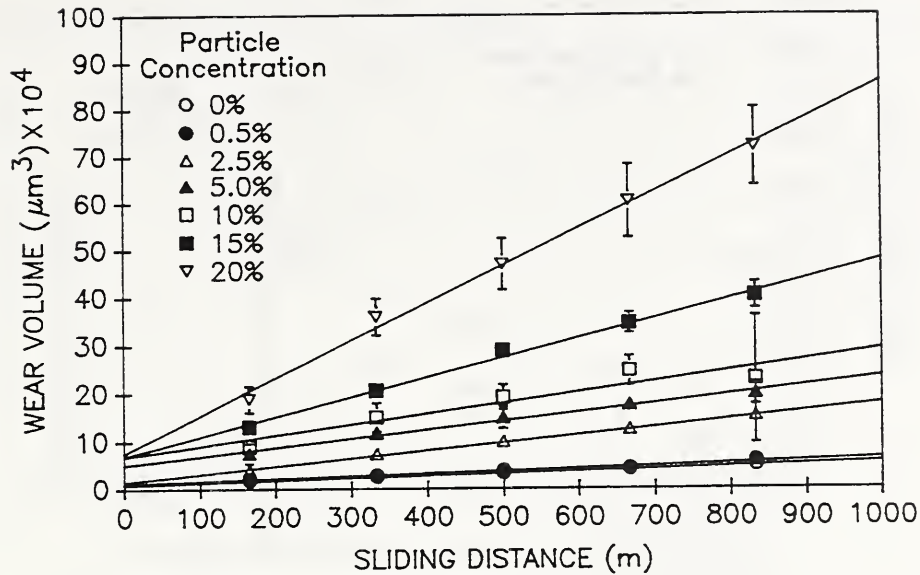

Fig. 8. Wear of 52100 steel pin as a function of sliding distance with different concentrations of combustor particles in mineral oil.

represent a linear least squares fit to each set of data. The fit is satisfactory in each case over the range extending from approximately 150 m to 830 m, indicating a linear relationship between volume-worn and sliding distance. The lines do not extrapolate to zero, however, as a result of an initially high rate of wear. This apparently was caused by the high contact stresses associated with the small contact area between the ball and flat at the beginning of the test. These results suggest that over the distance slid, except initially, the wear process did not change.

3.1.2 Particle Concentration

Wear rate values obtained from data shown in Fig. 8 are plotted as a function of particle concentration in Fig. 9. The dependence is seen to be relatively complicated. Initially, in the range from 0% to approximately 2% concentration, the wear rate rises rapidly. Subsequently, the wear rate continues to increase but at a less rapid rate until a concentration of about 20% is approached where the rate of increase accelerates somewhat. A similar behavior was observed for other particle types. However, the initial rate of increase in wear rate was strongly dependent on

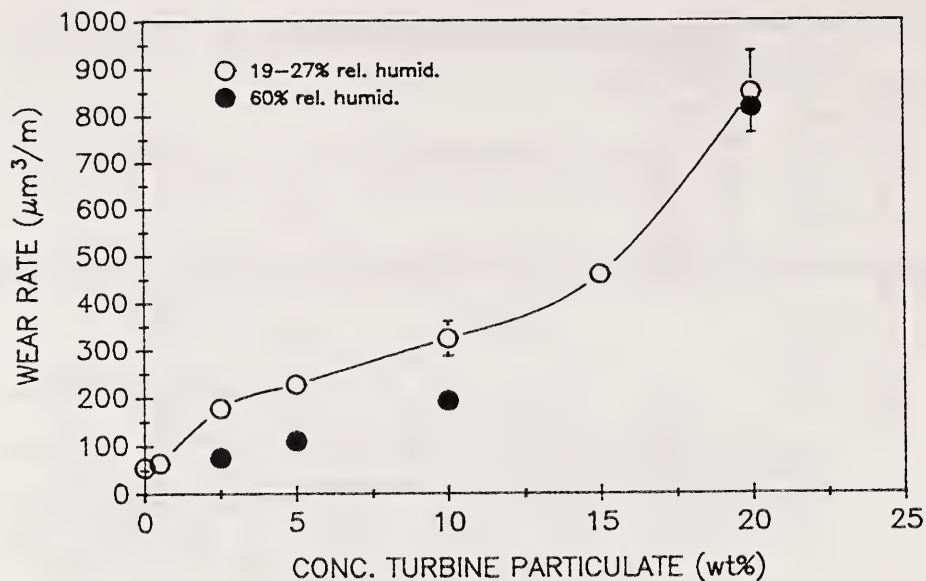

Fig. 9. Wear rate of 52100 steel pin as a function of combustor particle concentration in mineral oil at high and low relative humidities.

the hardness, or correspondingly the "abrasiveness", of the particles: the greater the abrasivity of the particulate, the higher the initial rate of increase in wear rate. This behavior is shown in Fig. 10 where wear rate is plotted on a log scale as a function of particle concentration for several different particle types.

The mechanism responsible for the complex dependence of wear rate on concentration was not determined. Employing the simplest model for abrasion, one would expect a linear dependence between particle concentration and wear rate. In this model, on average, each particle contributes to the removal of a certain amount of material. Increasing the concentration, that is increasing the number of particles contributing to abrasion in unit sliding distance, would result in a proportional increase in wear rate. Obviously other factors are important in the process. Clearly a proportional increase would only be expected if no more than one particle were in the contact at a given instant of time. If more than one particle were present, the average load per particle would be diminished resulting in a smaller penetration and the removal of less material per particle. On the other hand, high loads can lead to

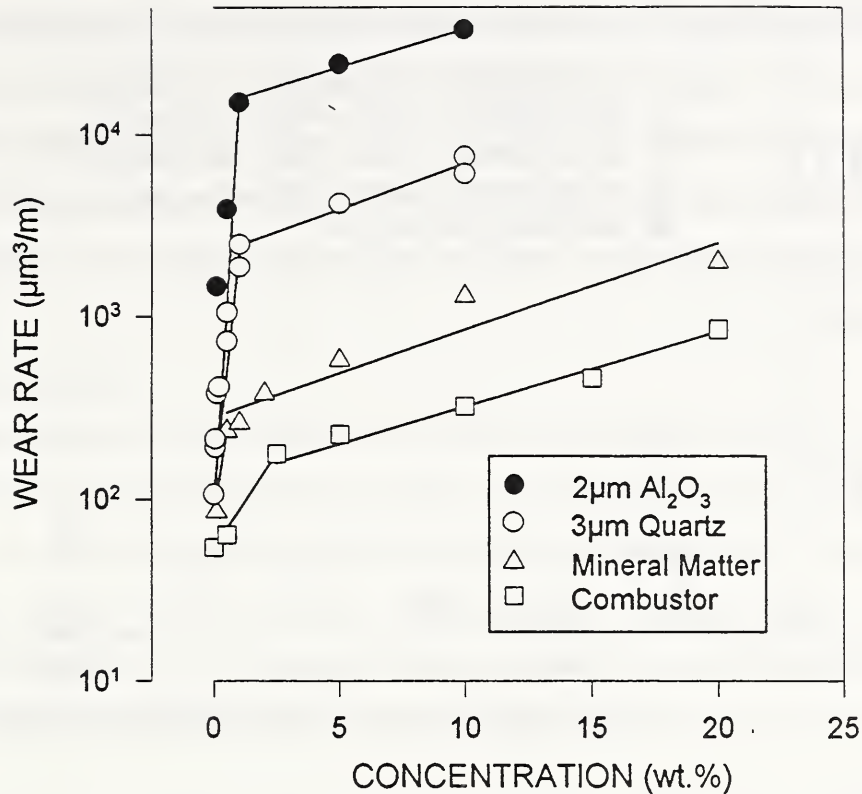

Fig. 10. Log of wear rate as a function of particle concentration

particle crushing and a lower wear rate because of the smaller resulting particle size, as discussed in the next section on particle size effects.

Fluid rheology can also play an important role. A series of experiments was conducted utilizing mixtures of coal-fuel particles and 1 µm quartz particles in mineral oil. In these experiments the concentration of quartz particles was held constant at 5% while the concentration of the coal-fuel particles was varied from 0% to 30%. Experiments were also conducted under the same conditions without quartz particles to establish a baseline for the influence of coal-fuel particles alone. The results are shown in Fig. 11. The tests were conducted over a period of time in which the relative humidity varied from 11% to 48%. Since relative humidity (Section 3.1.7) was found to have a significant effect on abrasion by quartz particles, the data are grouped into intervals of relative humidity.

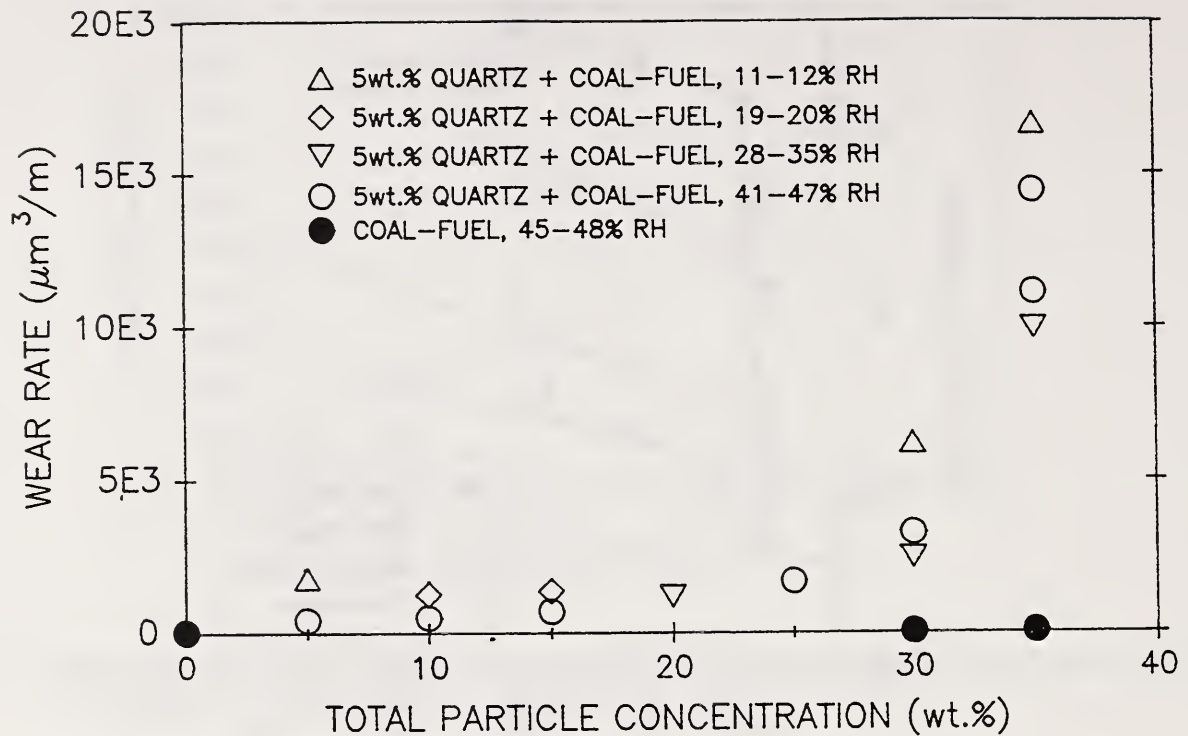

Fig. 11. Effect of coal-fuel particle concentration on wear by 5% 1 μ m quartz particles in mineral oil. 52100 steel pin specimens.

With 5% quartz particles present it is seen that the wear rate is little affected by the addition of coal-fuel particles until the total particle concentration exceeds approximately 25%. At higher concentrations the wear rate increases rapidly with increasing particle concentration. Tests were not conducted at concentrations higher than 35% because the mixture had the consistency of a thick paste and did not flow adequately for testing purposes.

Without the addition of quartz particles, abrasion due to the coal-fuel particles is seen to be too little to be displayed on the scale at which the data are plotted in Fig. 11. It is clear that the observed increase in wear rate is not due to abrasion by coal-fuel particles. The effect is apparently associated with the influence of particle concentration on fluid rheology and the manner in which fluid rheology controls the entry of quartz particles into the contact. At low total particle concentrations the fluid flows in front of and around the contact limiting the number of particles that enter the

contact. With increasing particle concentration and an associated increase in viscosity of the fluid, flow is impeded and more particles enter the contact. There is a resultant increase in the contact spacing between the pin and disk which contributes further to the entry of more and larger particles. Since wear rate is directly dependent on the number of particles that engage the contact surface, a significant increase occurs.

3.1.3 Quantity of Mixture

An interesting effect was observed in connection with a series of experiments in which the quantity of oil-particle mixture used in the test was varied. The results are shown in Fig. 12. The standard quantity of mixture employed was 2 ml (Table 2). The mixture was contained in the reservoir formed by the raised rim of the disk holder and the disk surface (Fig. 1). The actual depth of the oil film on the disk was determined by the lightly loaded vane used to direct the oil from the outer

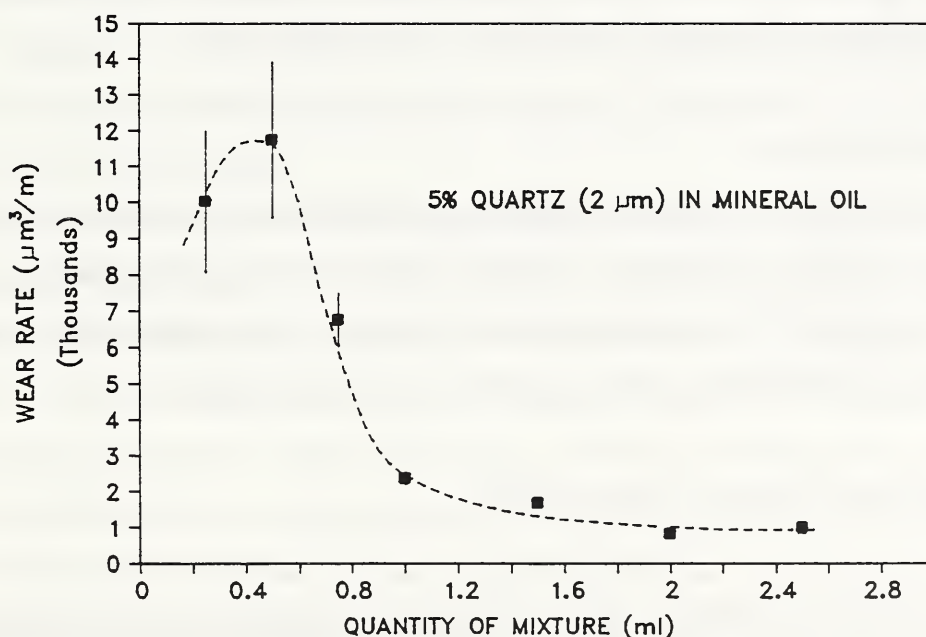

Fig. 12. Effect of quantity of mixture (5% Min-U-Sil in mineral oil) used for test on wear rate of 52100 steel pin.

circumference of the disk to its center during rotation. The depth was on the order of 10 μm or more depending on the viscosity of the mixture, and was well in excess of the amount needed to supply the contact. As shown in Fig. 12, the wear rate exhibits a relatively sharp maximum at approximately 0.5 ml falling rapidly with increasing volume until about 1 ml where the rate of decrease becomes more gradual. By the time 2 ml is reached the wear rate has become constant, independent of volume.

The observed behavior, as assumed in connection with the influence of particle concentration, can be attributed to an effect associated with the number of particles entering the contact. With large volumes, the flow of the fluid tends to carry the particles around the contact. As the volume, or depth, of the fluid is decreased, the flow is diminished and eventually nearly eliminated. The particles are now distributed on the disk surface in a thin film of oil and enter the contact without being swept aside by the flow of fluid. However, continued decrease in the volume of fluid also reduces the total number of particles, which explains the observed decrease in wear rate as the volume is reduced below 0.5 ml. Wear and comminution of the limited number of particles available undoubtedly contributes to this effect also.

3.1.4 Particle Hardness

Test results for four different types of particles having Knoop hardness values ranging from 34 kg/mm^2 (coal-fuel) to 2200 kg/mm^2 (aluminum oxide) are plotted in Fig. 13. The regression curve obtained by fitting the data obtained for magnesium oxide, quartz, and aluminum oxide is given by the relationship,

$$\text{Wear rate } (\mu\text{m}^3/\text{m}) = 39.3 e^{0.00357h} \quad (1)$$

where h is the Knoop hardness value. Thus, over the range extending from about 700 to 2200 kg/mm^2 the wear rate of 52100 steel is exponentially dependent on particle hardness. In Fig. 13 it is seen that the wear rate value obtained for coal-fuel particles lies above the extrapolated curve. This may be due to the presence of hard mineral particles in coal which make a substantial contribution to the measured wear rate.

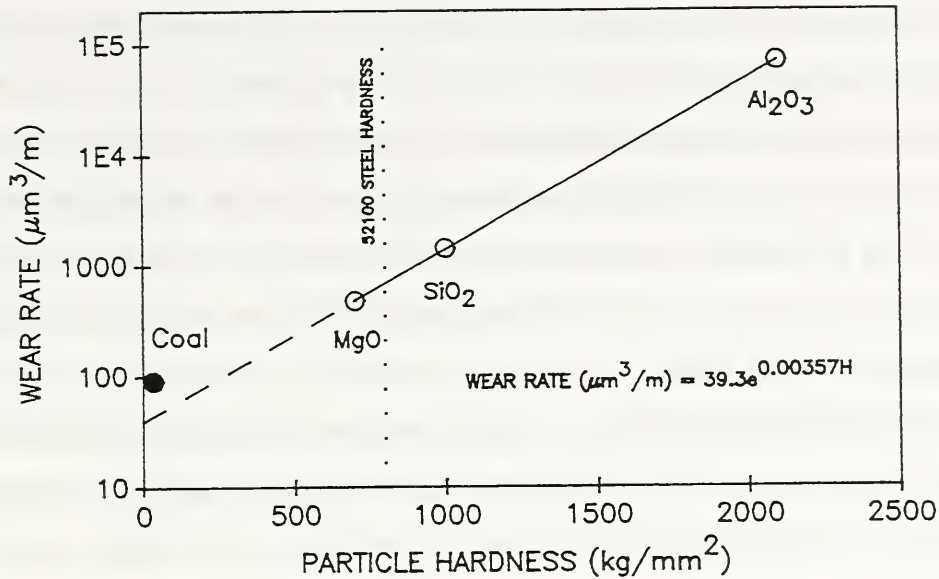

Fig. 13. Effect of particle hardness on wear rate of 52100 steel pin. 5% concentration, 2μm particles.

Alternatively, there is no reason, a priori, to expect that wear due to particles that are much softer than the contacting surfaces should follow the same trend as that for hard particles. In general, wear by soft particles occurs by a different mechanism, highly dependent on chemical reaction processes, than the mechanical mechanism associated with hard particles.

Never-the-less, Fig. 13 demonstrates the importance of particle hardness in an application such as the coal-fueled diesel engine. Assuming the same trend were followed in an operating engine, doubling the hardness from 1000 kg/mm² (quartz) to 2000 kg/mm² (Al₂O₃) results in a 50-fold increase in wear rate. In terms of qualifying a particular source of coal for diesel engine use, this result indicates that considerable emphasis should be placed on the hardness of the mineral content of the coal and associated combustion particles. Thus, a higher ash coal with relatively soft resultant particles might be more acceptable than a lower ash coal with harder associated particles.

It is interesting to compare the behavior displayed in Fig. 13 with that usually reported in the literature [20-22]. Typically, it is found that wear rate decreases rapidly

when the hardness of the abrading particles becomes less than about 0.8 times the hardness of the surface being abraded. On the other hand, when the abrading particles exceed the hardness of the surface by more than approximately 1.2, the wear rate is relatively high and approaches a constant value independent of particle hardness. In Fig. 13 there is no indication this asymptotic behavior for relatively hard particles. Both Al_2O_3 and SiO_2 are harder than 52100 steel with Al_2O_3 being substantially harder than SiO_2 .

Two other studies [23,24] were found that reported behavior similar to that obtained here; that is, increasing wear rate with increasing particle hardness without approaching an asymptotic constant value for particles much harder than the contact surfaces. In both cases the experiments involved abrasive particles in a lubricant. No explanation was offered for the observed effect.

It appears that the type of behavior observed depends on the conditions of the experiment. When the abrasive particles are supported by a relatively soft substrate such as occurs with abrasive paper, or when the load is supported by a high concentration of particles without appreciable stress on individual particles, abrasion occurs without appreciable fracture or crushing of the particles. However, when as in the present experiments only a few particles enter the contact at any instant of time, the stresses are high and the particles are subject to crushing. This, of course, occurs less for harder and correspondingly stronger particles. Thus, the abrasion is dependent not only on the hardness of the particles compared to the substrate but also on their resistance to crushing or friability.

3.1.5 Particle Size

In general, wear rate has been found to be strongly influenced by particle size over a size range extending from a fraction of a micrometer to approximately 200 μm . When the particle size is larger than 200 μm , size has been found to have relatively little effect. For particles less than about 0.1 μm the material removal process is closely related to polishing, and tribochemical reactions play an important and often dominant role. The particle size range which is important in connection with the coal-

fueled diesel engine extends from a fraction of a micrometer to perhaps 50 μm . Smaller particles are of course present in the form of soot. However, such particles are also present in the conventional oil-fueled diesel engine where they do cause wear but not at the extremely high rates that have been observed with coal-fuel related particles. Thus, it is likely that the contribution of soot particles will be relatively small compared to the larger coal-fuel and ash particles.

To examine the effect of particle size a series of tests was conducted utilizing the BCR quartz size-reference particles, Table 4. The results are shown in Fig. 14. The regression curve fitted to the points in Fig. 14 is given by

$$\text{Wear Rate } (\mu\text{m}^3/\text{m}) = 587 e^{0.44d} \tag{2}$$

where d is the nominal particle size. It is seen that particle size like particle hardness

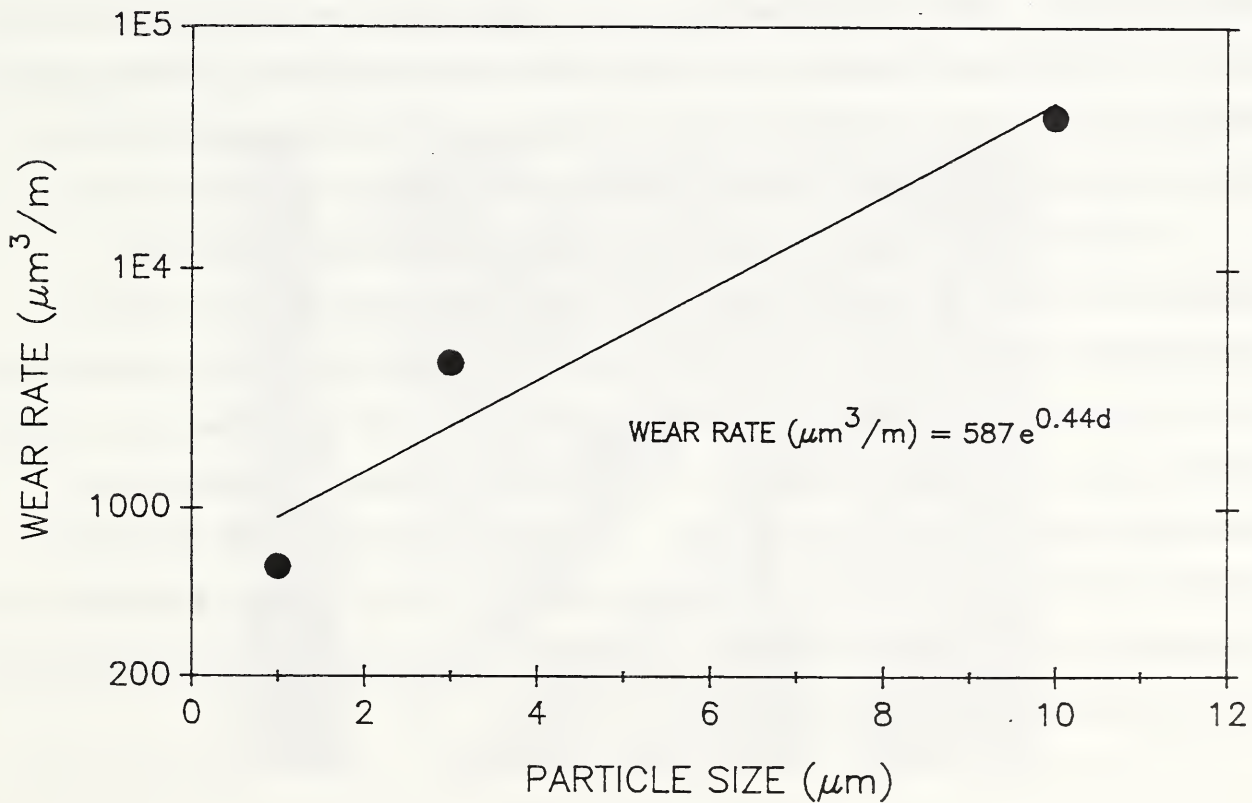

Fig. 14. Effect of quartz particle size on wear rate of 52100 steel pin.

has a significant effect on wear rate. For example, increasing the size from 1 μm to 10 μm , a factor of 10 results in an increase in wear rate by a factor of 50. If the same relationship were to hold in an operating engine, it is clear that maintaining as small a particle size as possible would have considerable benefit.

3.1.6 Particle Embedment

With quartz and the various coal related particles, effects associated with particle embedment in the disk were not observed. That is, having conducted a test with oil containing one of these types of particles, a subsequent test without particles in the oil gave the same wear rate, within the normally observed scatter as a test using a freshly prepared disk surface. However, after a test with Al_2O_3 particles, subsequent tests without particles gave substantially higher, but successively diminishing, wear rate values. An example of this behavior is shown in Fig. 15. Here, an initial test using a freshly finished disk surface was conducted without particles added to the oil. This was followed by a test in which 5% 2 μm Al_2O_3 was mixed with the oil. The subsequent series of tests was then conducted without particles added to the oil. The lubricant was removed after each test and the disk surface carefully cleaned before the next test. A new location on the pin was used for each test.

In the first test without added particles following the test with 5% Al_2O_3 particles, the wear rate is significantly higher than in the initial test on a freshly prepared disk surface. Comparatively high wear rate values were also obtained in the succeeding tests in the series. Despite the downward trend, even after nine tests the original value had not been recovered, indicating the persistent capability of the embedded Al_2O_3 particles to cause wear. To confirm the presence of embedded particles, the disk surface was examined in the SEM. Figure 16 is an example of an embedded particle. That this was an Al_2O_3 particle was established by the presence of Al and O peaks in the EDS spectrum.

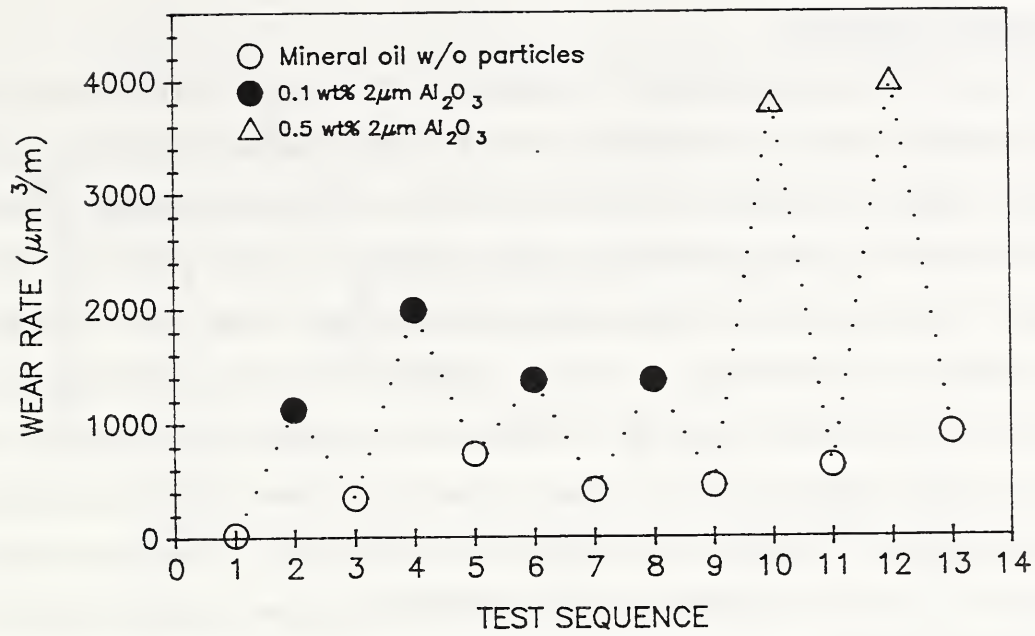

Fig. 15. Wear rate of 52100 steel pin in alternating tests with and without the addition of 2μm Al₂O₃ particles to mineral oil showing effect of embedment of particles in disk surface.



Fig. 16. SEM micrograph of Al₂O₃ particle embedded in 52100 steel disk.

3.1.7 Relative Humidity

Wear tests were conducted in ambient room air which was subject only to limited humidity control. Consequently, rather large changes in relative humidity occurred. Although a series of tests could often be completed during a period of time when the relative humidity remained nearly constant, in some instances this was not the case. It was found that rather marked differences in wear rate could sometimes be associated with the change in relative humidity. For example, it was necessary to take the prevailing relative humidity into account in plotting data included in Fig. 9. There, it is seen that wear rates for data collected at lower relative humidities (19 - 27%) are less than those obtained at 60% relative humidity. A similar effect was also observed in connection with tests with quartz and coal-fuel particles shown in Fig. 16. In both cases the effect of relative humidity appears to diminish at higher particle concentrations.

In a more systematic examination of the influence of relative humidity, a series of tests was conducted using $1\mu\text{m}$ quartz particles at a concentration of 1%. The results are shown in Fig. 17. The wear rate is seen to decrease by an order of magnitude with an increase in relative humidity from approximately 30% to 60%. The effect could be attributed to a decreased resistance to the removal of material from the surface of 52100 steel in the presence of moisture, perhaps as a result of a combination of corrosion and abrasion. It is more likely, however, that water vapor affects the fracture strength of the quartz particles. Thus, at high relative humidities the particles are more easily crushed and thus less able to penetrate and abrade the steel surface than at low humidities. It should be noted that this occurred despite the fact that sliding took place in mineral oil. However, the solubility of water in mineral oil is 1 or 2%. Moreover, the continued stirring and mixing action during the test offered ample opportunity for aeration of the oil so exposure of the particles was to a mixed air-oil environment.

Larsen-Basse [25] has investigated the influence of relative humidity on the abrasive wear of several metals and a borosilicate glass utilizing silicon carbide particles under conditions of three-body abrasive wear in an air atmosphere. No

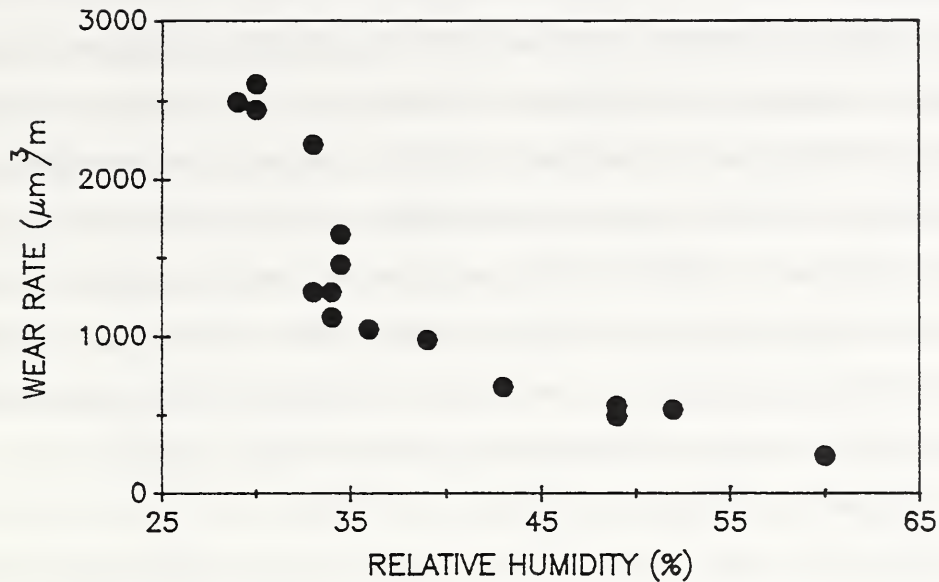

Fig. 17. Effect of relative humidity on wear rate of 52100 steel pin with 1% 1 μ m quartz particles in mineral oil.

lubricants were used in his tests. His results were quite different than those obtained here. When the relative humidity was above ~50%, the wear rate was found to increase with increasing humidity. Below 50%, changes in relative humidity had little effect. This is essentially opposite to the dependence observed in these experiments. Larsen-Basse determined that the average size of used particles was smaller for high humidities than low humidities and concluded that the particles were more easily fractured at high humidities. This, he hypothesized, produced sharper particles and, consequently, a higher wear rate. The production of sharp particles would certainly be important if the original particles were not sharp.

The contrasting results obtained in this investigation and that of Larsen-Basse demonstrates the importance of experimental details on the outcome of the experiment. That is, particle shape, and probably the manner in which the particles fracture (general crushing as opposed to fracturing of corners to produce a sharper edges, for example), as well as the general conditions of the experiment can have an overriding influence on the results.

3.1.8 Oil Additives

Many classes of lubricant additives exist which have the potential for influencing wear by abrasive particles. Among the most obvious of the commonly used additives that might be considered are those that modify the viscosity, wear, extreme pressure, corrosion, and particle suspension and dispersion characteristics of the lubricant. The nature of the response to a given additive will almost certainly depend on the contact conditions. And, indeed, the results may be beneficial or deleterious as has been discussed in previous work [26]. In the present investigation only one additive was studied, namely, the widely used antiwear motor oil additive zinc dialkyldithiophosphate (ZDDP).

To evaluate the effect of ZDDP, tests were conducted both with 0.2% ZDDP and without the additive in mineral oil. Combustor particles at a concentration of 5% were employed as the abrasive. The results are shown in Fig. 18. Without abrasive particles it is seen that the addition of 0.2% ZDDP resulted in a slightly lower wear rate. This is consistent with the fact that the tests were conducted under boundary lubrication conditions where the antiwear properties of ZDDP are effective. Repeating

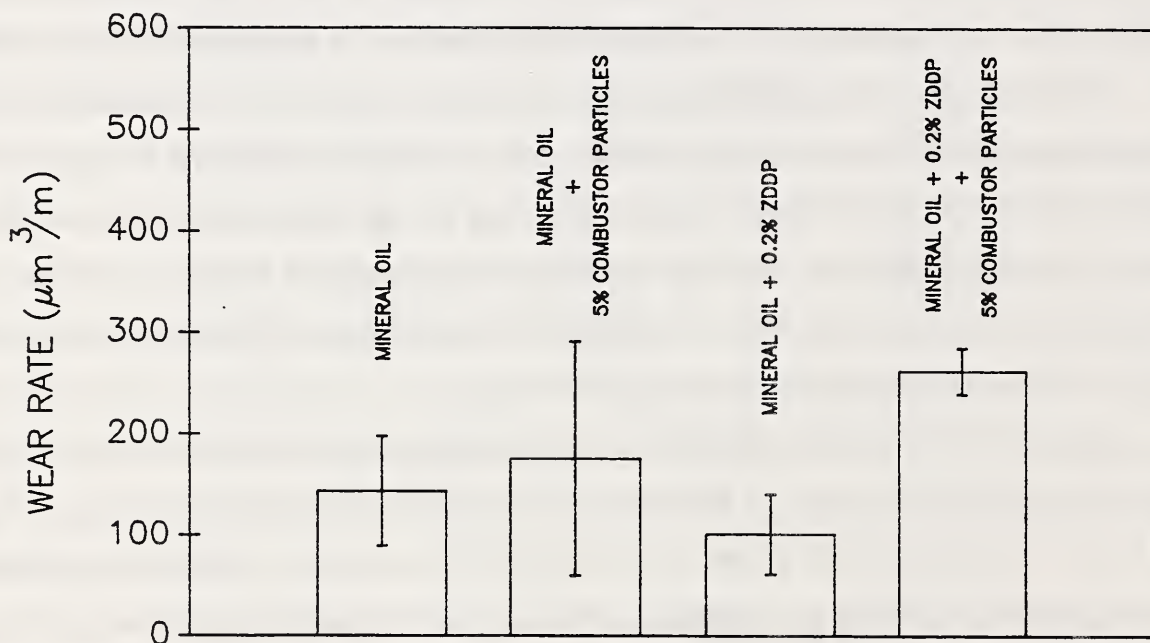

Fig. 18. Effect of the addition of 0.2% ZDDP on the wear rate of 52100 steel pin.

the experiment with 5% combustor particles, however, resulted in a higher wear rate with mineral oil containing ZDDP. One mechanism by which the observed behavior can be explained is as follows: The addition of ZDDP results in the formation of a relatively soft tribochemical reaction film on the steel surface, protecting it from severe adhesive wear. However, in the presence of abrasives, this film is rapidly worn away providing a fresh metal surface for reaction with the ZDDP. As a result the wear rate is higher than that obtained without ZDDP and the enhanced tribochemical reaction. Other mechanisms could, of course, contribute to or be responsible for the increased wear rate. For example, ZDDP could improve the efficiency of chip formation as is claimed for sulfur containing additives in grinding fluids [27].

3.1.9 Different Types of Coal-Related Particles

In previous sections results obtained with coal-related particles were used in several instances to study the influence of experimental variables. However, little attention was given to examining the abrasive characteristics of the particles themselves. Figure 10, in addition to showing the effect of particle concentration on wear rate, demonstrates that the coal related particles, combustor particles, and mineral matter particles, are all considerably less aggressive than quartz and Al_2O_3 particles. It should be noted that the mineral matter particles ($4\mu\text{m}$) and combustor particles ($5\mu\text{m}$) were also somewhat larger than the quartz particles ($3\mu\text{m}$) and Al_2O_3 particles ($2\mu\text{m}$). Since wear rate increases with particle size, the difference in abrasivity among the four particle types would be even greater on an equivalent particle size basis than shown in Fig. 10.

The comparison between the coal derived particles and quartz particles is of special interest, since quartz particles are a constituent of the coal derived particles. The much greater wear rate with quartz particles confirms the analytical finding (Section 2.3) that the concentration of quartz particles in the combustor and mineral matter materials is relatively low. In addition, the results indicate that no other particle type of equal or greater abrasivity than $3\mu\text{m}$ quartz is likely to be present at a significant concentration.

Figure 19 provides a direct comparison of the wear rate generated by three different coal-related particle types. The baseline wear rate obtained with mineral oil in the absence of particle additions is also indicated. Each of the particle types would, of course, be a component of the mixture of particles present at the cylinder wall and in the lubricating oil of an operating coal-fueled diesel engine. The separate comparison is important because it helps to gain an insight regarding the sources of

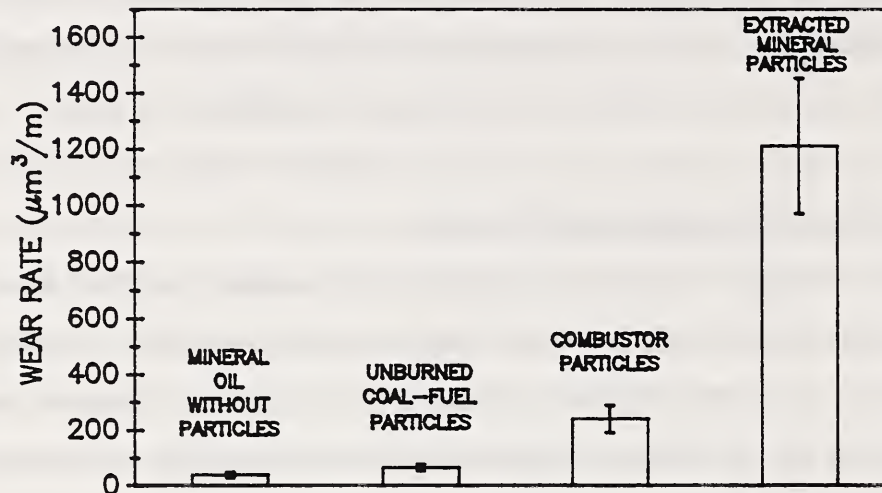

Fig. 19. Wear of 52100 steel pin lubricated with mineral oil and mineral oil containing 10% of three different coal related particles.

wear. It is seen that at the 10% concentration level, the presence of coal-fuel particles results in about a 65% increase in wear rate, the combustor particles a 6-fold increase, and the highly aggressive mineral matter particles a 30-fold increase. In general, the differences in severity can be related to the concentration of mineral particles since it is clear that the carbonaceous material comprising the coal contributes relatively little to the observed abrasive wear. Mineral particles are present in the coal-fuel at a concentration of about 1%. The combustor material was found to be approximately two-thirds mineral related by mass, and much of the mineral-related material was in the form of hollow spheres, or fly ash, generated during combustion.

The fact that the mineral matter particles resulted in five times greater wear rate than the combustor particles is probably related to the lower abrasivity of the spherical particles compared to angular particles.

The results confirm the obvious fact that reducing the concentration of mineral elements in the coal-fuel would be the most direct means of reducing wear. But having reached the feasible limits in that regard, substantial benefits could also be gained by minimizing the extent to which particles are allowed to accumulate on the cylinder wall and in the lubricating oil.

It should also be pointed out that the results in Fig. 10 demonstrate that in the evaluation of materials for coal-fueled diesel applications highly abrasive particles such as Al_2O_3 , and even quartz at high concentrations, might generate misleading results. Mineral matter, combustion particles, or quartz at low concentrations would provide a better measure of a materials performance.

3.1.10 Wear of Selected Materials

It has already been pointed out that practical experience has shown that conventional piston ring and cylinder liner materials wear excessively during coal-fuel operation. Conventional materials range from relatively soft gray cast iron to much harder chromium plating. Despite the fact that the latter material may approach quartz in hardness, it still exhibits an extremely high rate of wear during coal-fuel operation [14].

Tests were conducted on a variety of materials including pure metals, several metal alloys, glass, cermets, and ceramics. These materials were utilized as the pin specimen. The counterface disk material was always hardened 52100 steel for these experiments. Table 1 gives a brief description of the pin materials and their hardness. Some materials were tested in the form of balls while others were machined into a conical shape for testing. The three-pin test configuration was utilized.

Two different particulate materials were used in the tests: GE filter residue and extracted mineral matter. The filter residue provides an approximate simulation of particles that might actually be present in an operating coal fueled diesel engine. The

mineral matter particles, on the other hand, provide a worst-case abrasive condition, as discussed in the previous section, while still utilizing a particle collection that is representative, at least, of that found in a particular coal-fuel, Blue Gem coal-fuel. The filter residue was mixed at a concentration of 50% with mineral oil leading to a final particle concentration of about 25%. The mineral matter particles were mixed at a concentration of 20%. After tests with the filter residue, the central region of the pin wear scar was sufficiently smooth to allow measurement of Knoop hardness indentations introduced at a load of 2N. Thus, the hardness data in Table 1 were obtained from these pins. After testing with mineral matter particles, the softer materials, in particular, contained relatively deep scratches and were not suitable for hardness measurements.

Prior to conducting a test, the pins were "preworn" by polishing with 0.25 μm diamond paste to produce a flat contact area with a diameter of 0.75 - 1.00 mm. The load applied to each pin was 5.6N, resulting in a contact pressure which is comparable to the maximum ring contact pressure typical of an operating diesel engine. The remaining test conditions are given in Table 2.

Test results obtained with the filter residue particulate material are shown in Fig. 20. The measured wear rate values are plotted as a function of pin hardness. It is clear that the wear rate is not a simple function of hardness. This should not be surprising in recognition of the complexity of the test conditions leading to a combination of adhesive, abrasive, and tribochemical wear modes; the diversity of materials having different mechanical, chemical, and microstructural properties; and the complicated nature of the lubricant-particle mixture consisting of several different particle types. The wear rates among materials less than approximately 500 HK in hardness are especially variable and in some cases quite high. Perhaps the most important observation that can be made in connection with Fig. 20 is that very low wear rates occur for materials greater than approximately 1000 HK in hardness (zirconia, silicon nitride, sapphire, and WC-6Co). This finding is consistent with a general rule regarding abrasive wear. Namely, the rate of abrasion decreases markedly when the hardness of the surface being worn is greater than about 0.8 times

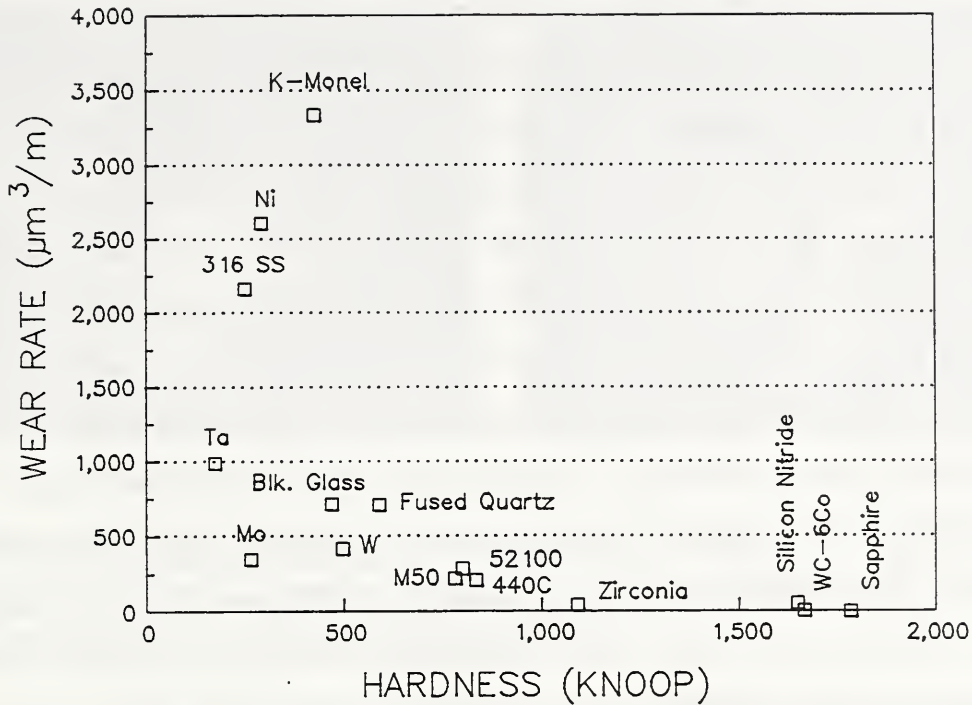

Fig. 20. Wear rates for different pin materials against 52100 steel disk lubricated 1:1 mixture of mineral oil and coal-fuel operated diesel engine filter residue.

the hardness of the abrading particles. In this instance quartz, with a hardness of about 1000 HK, is the hardest particle type present at a significant concentration. Thus, the low wear rates of materials harder than 1000 HK is in agreement with the general rule regarding relative particle hardness. It may also be noted that these materials are also substantially harder than the 52100 steel disk and this probably makes an additional contribution to their comparatively low wear rates.

Among the four hard materials (zirconia, silicon nitride, sapphire, and WC-6Co), sapphire exhibited an extremely low wear rate. In fact, the volume loss could not be measured in terms of an increase in scar diameter, even though the sliding distance was in excess of 3×10^4 m. Wear was only evident as a consequence of scratches in the original polished surface. Presumably, after a sufficiently large sliding distance, the accumulation of such scratches would result in a measurable increase in scar diameter.

The wear rate of WC-6Co was extremely low ($5 \mu\text{m}^3/\text{m}$). Silicon nitride and zirconia also exhibited low wear rates but about an order of magnitude higher than WC-6Co. Zirconia is softer than WC-6Co and this could account for its comparatively higher wear rate. Silicon nitride is about equal in hardness to WC-6Co so its higher wear rate apparently can not be explained by a difference in hardness. However, WC-6Co is a composite and the individual WC grains are considerably harder (20 GPa) than the bulk composite (16 GPa). Under relatively mild abrasive wear conditions as in this experiment, the thin intergranular layer of Co binder rapidly recedes leaving the much harder WC grains exposed. The wear rate is then controlled mainly by the WC grains. It might also be argued that the greater toughness of WC-6Co compared to silicon nitride ($K_{Ic} \approx 15 \text{ GPa}\cdot\sqrt{\text{m}}$ for WC-6Co and $\approx 7 \text{ GPa}\cdot\sqrt{\text{m}}$ for silicon nitride) might be a factor in favor of WC-6Co. Since there was no evidence of microfracture in the worn surfaces of either material, toughness may not have played a significant role. Finally, tribo-oxidation has been found to play a significant role in the friction and wear of silicon nitride [28] and probably made a significant contribution here.

Although there was no general evidence of fracture associated with the wear of WC-6Co, damage existing prior to sliding did produce a pronounced effect. Figure 21a shows a Vickers hardness indentation introduced before sliding commenced, and Fig. 21b shows the same indentation after sliding for a distance of $3 \times 10^4 \text{ m}$. It is clear that microcracks in the vicinity of the indentation have led to extensive damage during sliding. For sapphire, which is considerably more brittle than WC-6Co, even more severe damage was observed at hardness indentations after sliding. In a practical application, damage as a result of machining could lead to rapid degradation of the surface. This indicates that initial surface integrity can be an important factor with respect to wear, and is especially critical for materials with low fracture toughness.

Results obtained when 20% mineral matter particles were mixed with mineral oil are shown in Fig. 22. For the same pin materials, the wear rates are in most cases several times higher than with filter residue particles. This can be attributed to the larger mean size of the mineral matter particles and, almost certainly, to the larger concentration of hard particles present. Nevertheless, on an absolute basis the wear

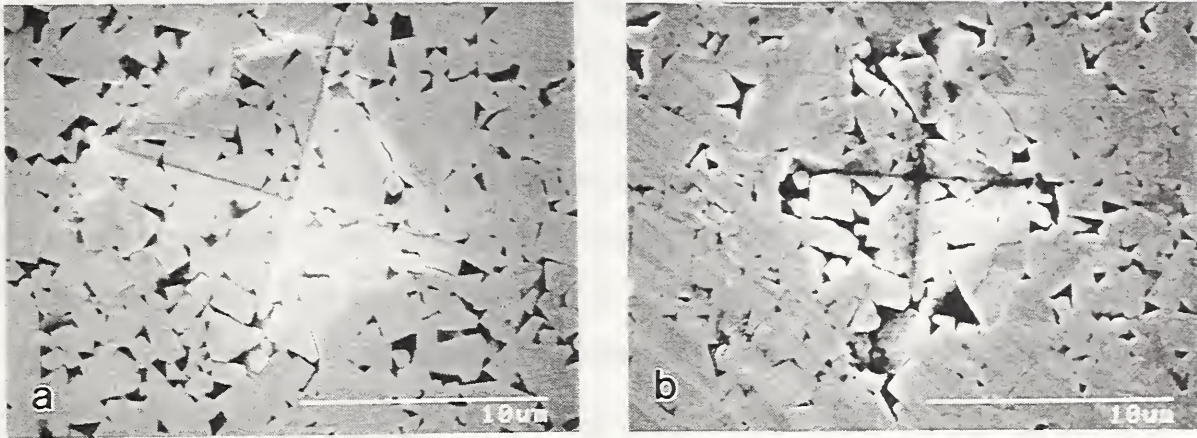

Fig. 21. Vickers hardness indentation in WC-6Co pin. (a) Before test and (b) after sliding 3×10^4 m in lubricant consisting of 1:1 mixture of mineral oil and coal-fuel operated diesel engine filter residue.

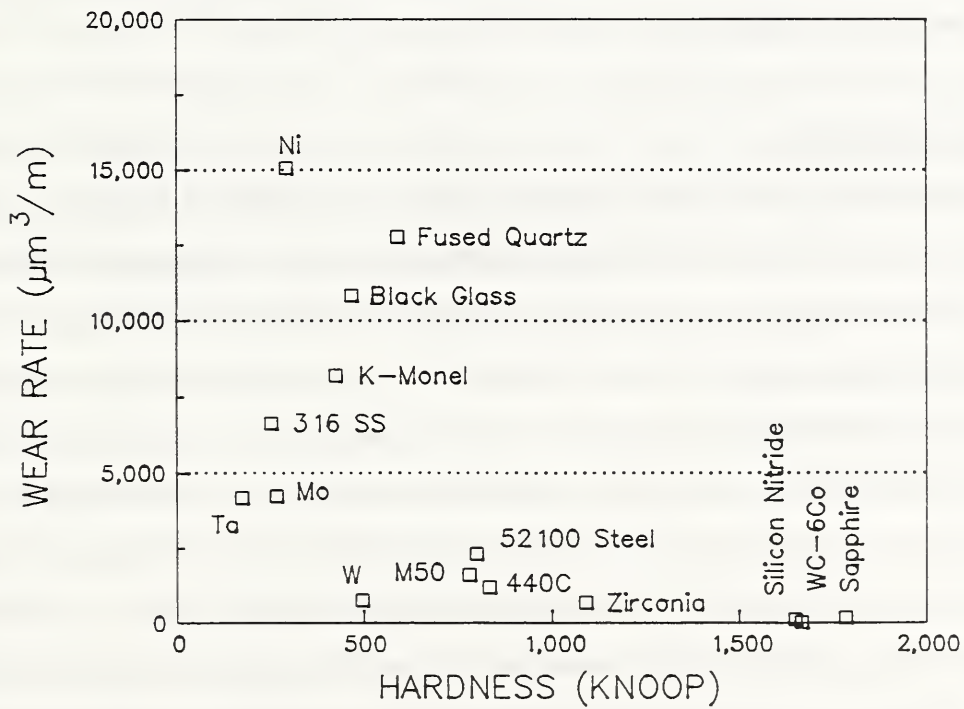

Fig. 22. Wear rates for different pin materials against 52100 steel disk lubricated with mineral oil containing 20% mineral matter particles.

rates are still quite low for pin materials harder than 1000 kg/mm². It is interesting that sapphire, which experienced almost no detectable wear with filtrate particles, now exhibits a higher wear rate than either silicon nitride or WC-6Co. Examination of the worn surface of the sapphire pin revealed evidence of lateral fracture in the vicinity of scratches. Such fracture was not observed at scratches in the wear scars on silicon nitride and WC-6Co. The larger particles present in the mineral matter material apparently produced sufficiently high stresses to cause fracture of the more brittle sapphire. The fracture mode of wear will, in general, result in a higher wear rate than the ductile mode.

These results are a clear indication of the importance of both hardness and toughness in the selection of an abrasion resistant material. If the abrasion conditions are such that the brittle mode of material removal is of little consequence, as can be the case when the abrasive particles are sufficiently small, then the hardest material can provide the greatest wear resistance. However, under conditions that might lead to a brittle removal process, selection of a less hard but tougher material might provide better performance.

3.1.11 Wear of WC-6Co

Cemented carbides combine high hardness, significant toughness, and offer excellent resistance to both abrasive and adhesive wear. Because of these attributes, cemented carbides are used extensively in such demanding applications as rock drilling, machining and metal forming operations. It is not surprising, therefore, that they would also be leading candidates in the fabrication of piston rings and cylinder liners for coal-fueled diesel engines. Cemented carbides can be employed in sintered-monolithic form or as coatings. Commonly used compositions consist of tungsten carbide particles with a binder or matrix phase of 6 to 12% cobalt. A variety of other compositions exist, however, and selection is based on the requirements of the specific application. In general, wear resistance is dependent on both carbide and binder composition, the content of each component, and the carbide particle size [29,30].

To obtain additional information on the abrasion behavior of WC-6Co, experiments were conducted with four different types of particles in mineral oil. The particles were 2 μ m quartz, 1 μ m and 3 μ m Al₂O₃, and 1 μ m diamond. To account for the different densities of these particulate materials, the same volume concentration (40%) of each particle type was used. The tests were conducted without a preworn flat on spherical WC-6Co pins. Sliding was against a 52100 steel disk. The tests were terminated when a scar diameter of approximately 0.4mm was reached rather than after a fixed sliding distance. This was done to avoid possible effects on wear rate associated with the large difference in scar size that would result in fixed sliding distance test with particles having such a wide range of abrasivities. The remaining test conditions are given in Table 2.

Wear rate results are shown in Fig. 23. As expected, the lowest wear rate was obtained with the softest particulate material, quartz, and the highest wear rate with the hardest material, diamond. Notice, however, that while the hardness-ratio relationship, quartz:Al₂O₃:diamond, is approximately 1:2:10, the corresponding wear rate ratio is 1:3:5 $\times 10^4$. That is, the wear rate ratio is extremely large and not in proportion to the hardness ratio. As indicated in previous discussion this difference is a response to different abrasion mechanisms which occur with particles that are soft compared to particles that are hard relative to the material being abraded. Quartz with an approximate hardness of 10 GPa is softer than WC-6Co which has a hardness of 16.6 GPa. Al₂O₃ with a hardness of 21 GPa is apparently harder than WC-6Co, but the difference is not so great when one considers that the individual WC grains have a hardness that is approximately equal to that of Al₂O₃. As noted above, when the scratches introduced by abrasion are small compared to the carbide grain size, the hardness of the carbide grains will play a more dominant role than the bulk hardness.

In effect the above experiment involved quartz particles that were relatively soft compared to WC-6Co, Al₂O₃ particles that were approximately equal in hardness to WC-6Co, and diamond particles that were much harder than WC-6Co. Thus, material removal by quartz and Al₂O₃ particles was mainly the result of a polishing process, involving tribochemical mechanisms, plastic deformation, and perhaps fatigue effects.

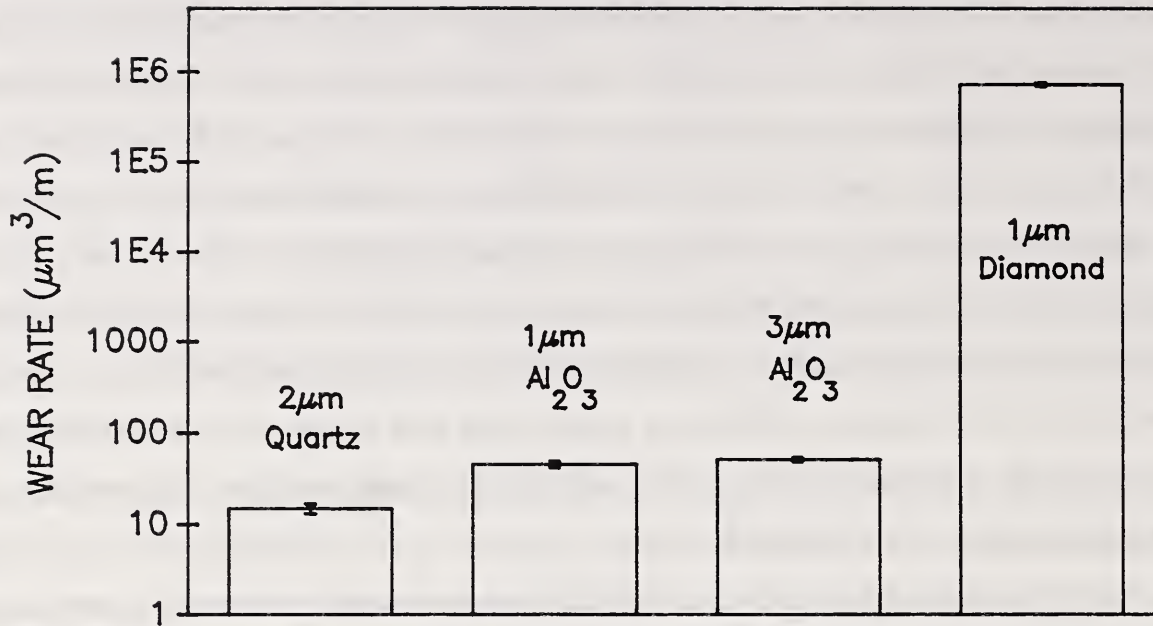

Fig. 23. Wear rate of WC-6Co pin by different particles in mineral oil at a concentration of 40 volume percent.

The scar on a WC-6Co pin after a test with 1 μm Al_2O_3 particles is shown in Fig. 24a. Apart from a number of pits, the surface is quite smooth and polished in appearance. Many of the pits are a result of preferential removal of unreacted carbon that remained after sintering. The remaining pits may have resulted from grain pull-out or were originally pores in the material that were exposed by wear. Only with the larger 3 μm Al_2O_3 particles were a few scratches observed.

Fig. 24b shows the scar surface after a test with 1 μm diamond particles. In this case the presence of relatively deep scratches is quite evident. It is apparent that the hard diamond particles were able to penetrate the surface and cut grooves to remove material. With a wear rate approximately four orders of magnitude greater than achieved with quartz or Al_2O_3 , this mechanism is clearly of substantially greater efficiency. These results are a convincing indication of the importance of avoiding a condition where the abrading particles are harder than the contacting surfaces.

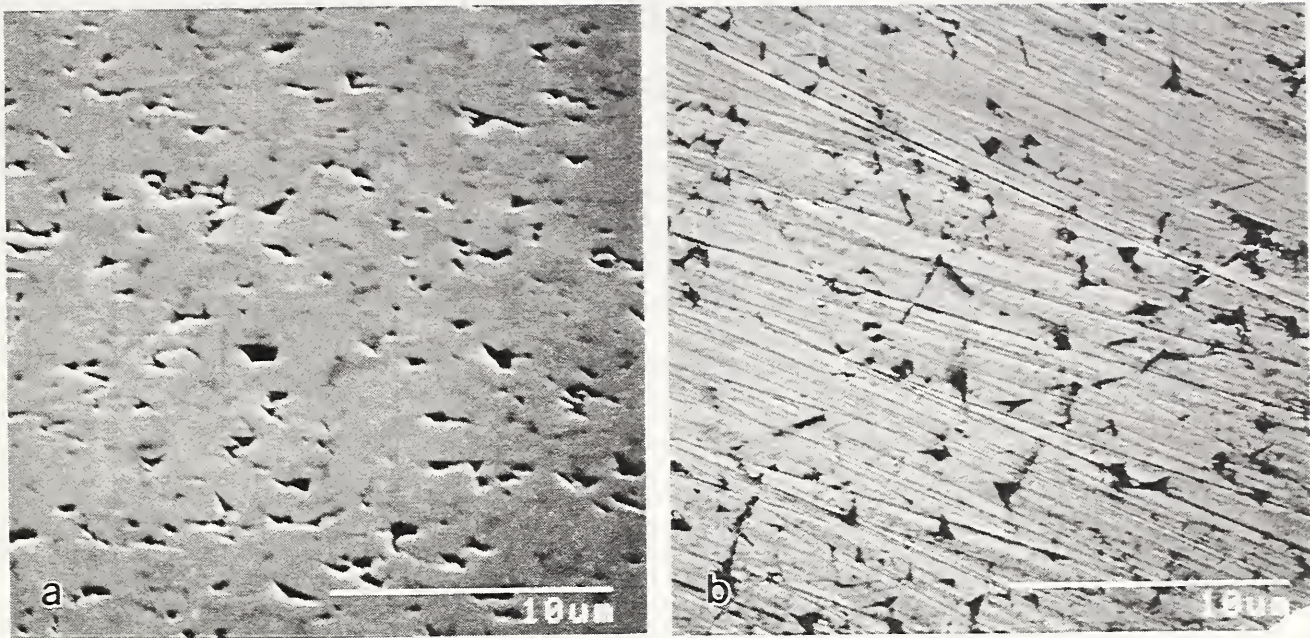

Fig. 24. SEM micrographs of WC-6Co pin surfaces. (a) after wear by 1 μm Al_2O_3 particles and (b) after wear by 1 μm diamond particles.

3.2 Block-On-Ring Test Results

The block-on-ring test was employed mainly to investigate the influence of sliding motion on wear rate. This was achieved by comparing the results obtained by operating the machine in a unidirectional sliding mode and in a reciprocating or oscillating sliding mode [7]. Details of the block-on-ring test setup and operating conditions are described in the Experimental Procedure section and in ref. [7].

Two different sizes of quartz particles were used in the tests: 2 μm and 10 μm . Results for unidirectional and reciprocating sliding with the two particle sizes are shown in Fig. 25. For comparison, data were also obtained without the addition of particles to the oil. The general response is similar to that obtained with the pin-on-disk configuration. Thus, the wear rate is increased substantially with the addition of particles to the lubricating oil, and the wear rate associated with the smaller 2 μm particles is significantly less than with the larger 10 μm particles. The new information appearing in Fig. 25 concerns the influence on wear rate of unidirectional and

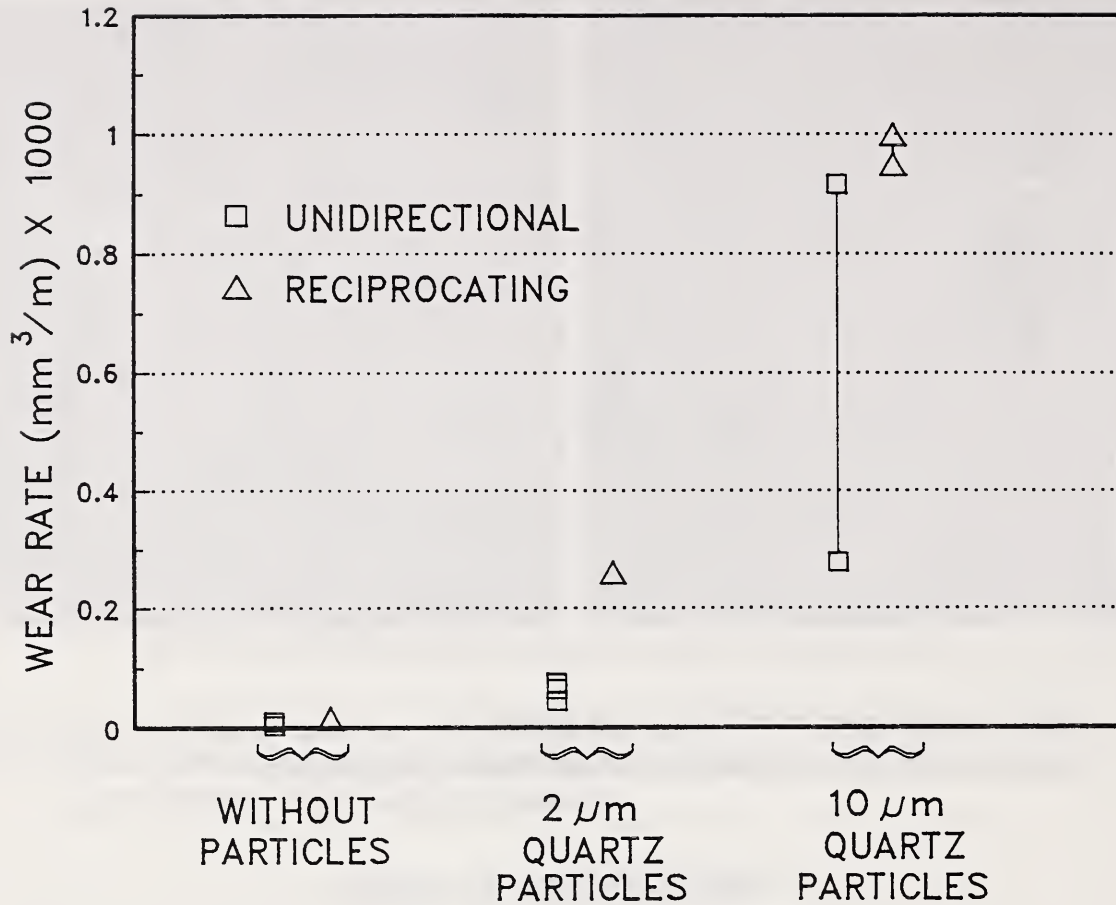

Fig. 25. Wear rates in reciprocating and unidirectional sliding modes for 2 μm and 10 μm quartz particles in mineral oil and in mineral oil without added particles.

reciprocating sliding. With the exception of one data point, higher wear rates were obtained with reciprocating motion for both small and large particles than with unidirectional sliding.

The friction force was measured during the tests and the average coefficient of friction values derived from these measurements are plotted in Fig. 26. The values are typical of sliding under a condition of boundary lubrication for the low viscosity oil used. It is seen that the addition of particles to the oil results in an increase in the coefficient of friction. Moreover, the increase is greater for the larger 10 μm particles. The increase in coefficient of friction can be attributed to the additional force associated with the scratching and plowing action of the particles in the contact.

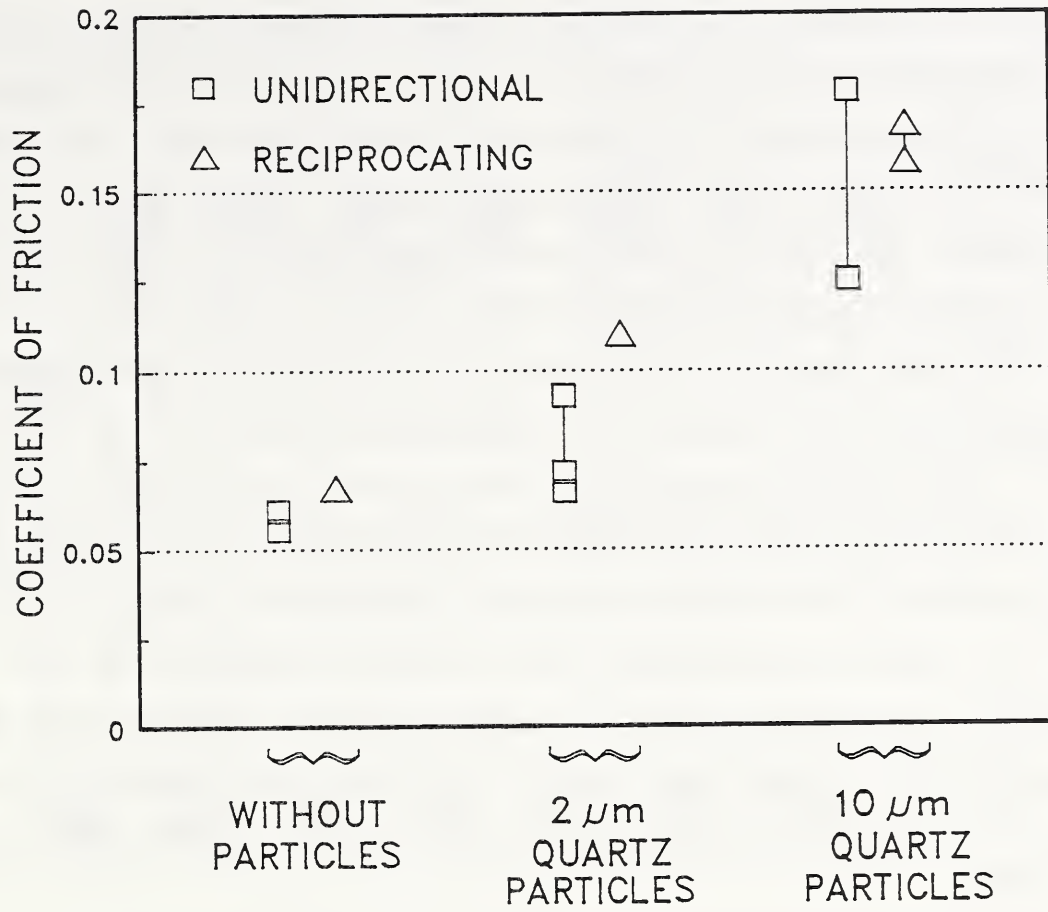

Fig. 26. Coefficient of friction values for different test conditions.

Sliding of the abrasion-roughened block and ring surfaces may also contribute to the increase. The higher coefficient of friction with the larger particles is apparently a result of the deeper scratches.

The variation in friction force over several cycles in the reciprocating mode for a test with 10 μm particles is shown in Fig. 27. Apart from short term fluctuations, the friction force remains relatively constant during each half cycle. There is no indication that the friction force decreases in regions of maximum sliding speed at the center of each half cycle. Such a decrease would indicate the transition to a condition of hydrodynamic lubrication. Thus, sliding remains in the boundary lubrication regime throughout. Substantially higher speeds and/or a smaller load would be required for transition to a hydrodynamic condition.

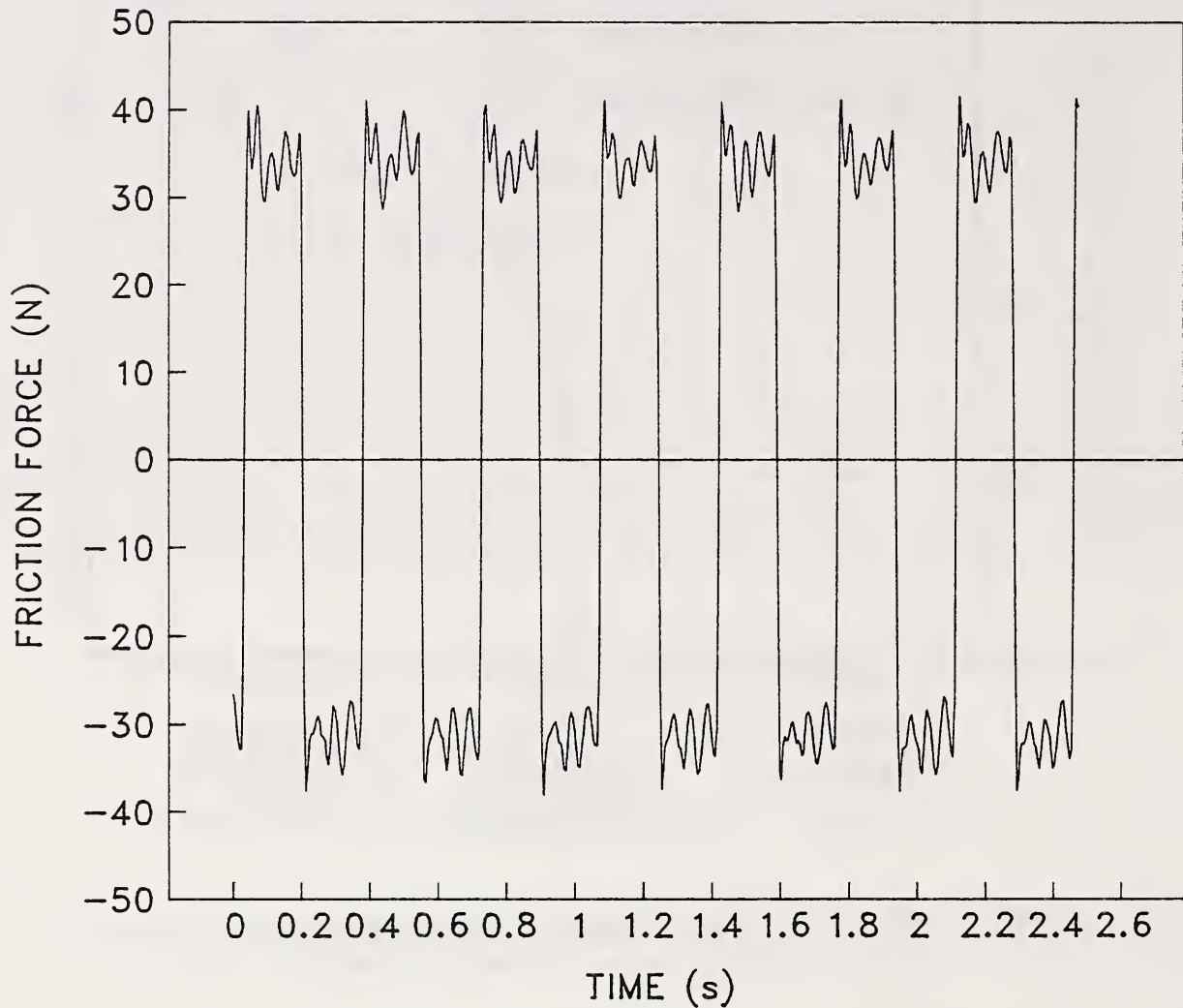

Fig. 27. Friction force variation during reciprocating sliding with $10\ \mu\text{m}$ particles in mineral oil.

In an operating diesel engine the ring/cylinder wall contact conditions are such that sliding is in the hydrodynamic regime throughout most of the cycle. The boundary regime is entered only briefly during top and bottom reversal of the piston. In this respect, then, the block-on-ring contact conditions in the reciprocating mode did not simulate the conditions in an operating diesel engine. Therefore, the variation from relatively thick to essentially zero film thickness associated with the hydrodynamic and boundary regimes, respectively, did not occur.

An indication of the importance of a varying film thickness was obtained in some experiments in which the ring axis, unintentionally, was not accurately parallel to the spindle axis of the test machine. As a result, the ring executed a periodic rocking motion at the block contact. Thus, a slight gap was opened first at one side and then at the other side of the contact. Greater wear was observed at the ends of the contact than in the center. Moreover, misalignment resulted in a significant increase in the average rate of wear and this was responsible for the high wear rate data point noted in Fig. 25. The increased wear rate was attributed to the improved access of particles during the periodic opening of the gap at the sides of the block.

A micrograph of a wear scar that resulted from a misaligned ring is shown in Fig. 28. The scar is not only wider but appears rougher at the ends than in the center. Note the indentations adjacent to the inlet edge (the top edge in Fig. 28) of the scar where particles were first engaged. The surface topography of the scar is shown in more detail in Fig. 29a and b. The end region shown in Fig. 29a exhibits a profusion of indentations. Apparently this was caused by the entrapment of particles

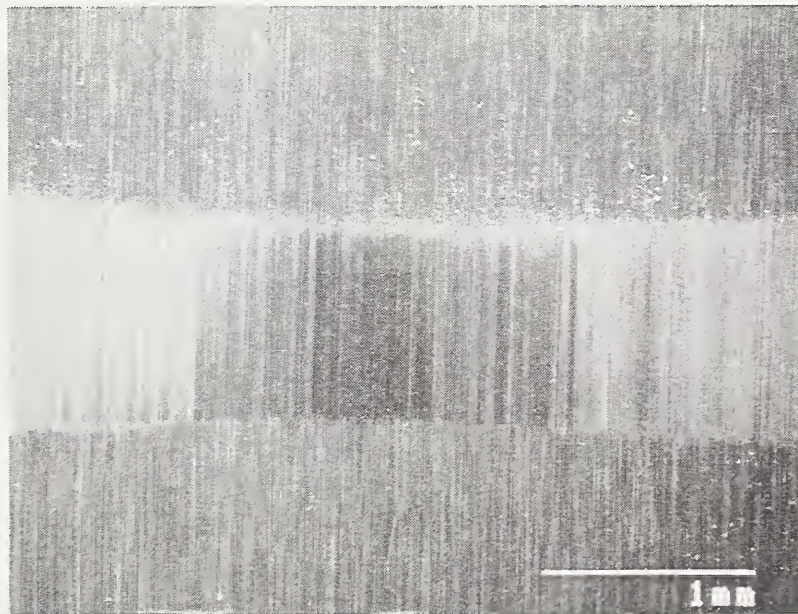

Fig. 28. SEM micrograph of wear scar on block with misaligned ring surface after unidirectional sliding test with 2 μm quartz particles in mineral oil.

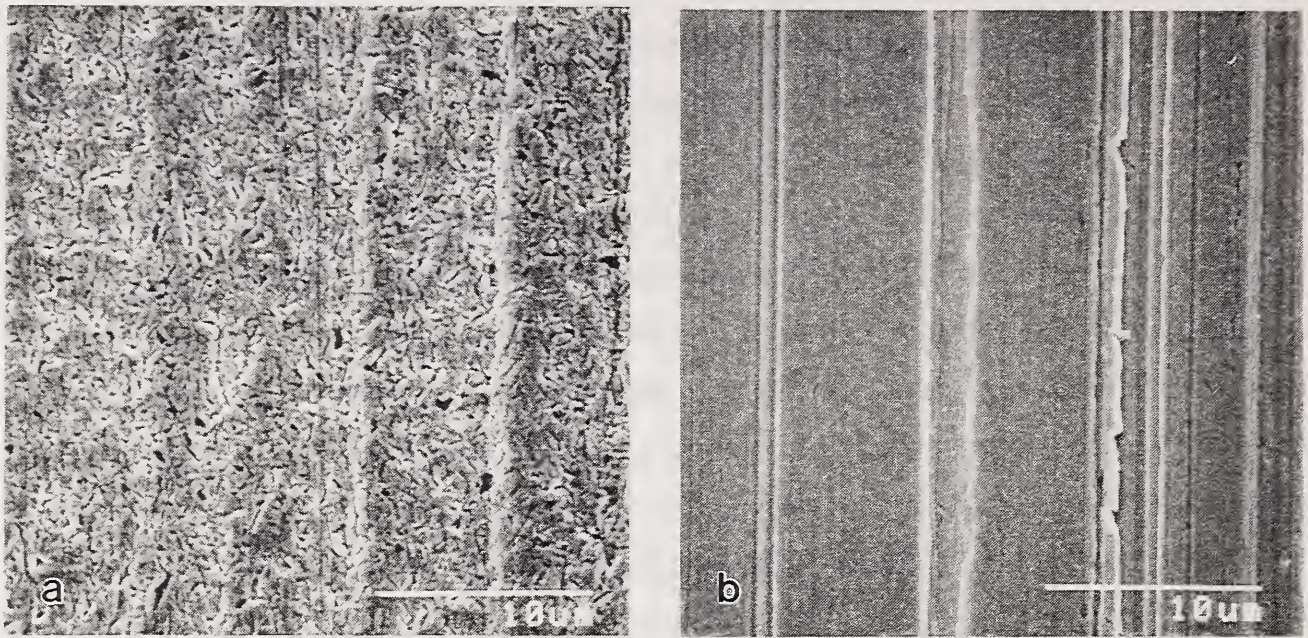

Fig. 29. SEM micrographs of scar in Fig. 4 at higher magnification showing surface details in end region (a) and center region (b).

which entered the contact when the gap was open. The center of the scar shown in Fig. 29b is polished in appearance with parallel grooves differing in depth and width.

Debris particles collected at the outlet end of the contact during tests with $2\mu\text{m}$ and $10\mu\text{m}$ particles are shown in Fig. 30a and 30b, respectively. For comparison, micrographs of corresponding unused particles are shown in Fig. 31a and b. For both tests the rings were well aligned and the scars were uniform in width. It is quite clear that the particles that exit the contact are substantially smaller than those that enter the contact in both cases. The most likely explanation for this is that large particles that enter the contact are crushed. Rejection of large particles because of the extremely small clearance between the block and ring surfaces is another possible explanation. However, indentations at the entrance region of the contact indicates that many large particles were trapped and not rejected.

In addition to quartz particles, metal particles from the steel block and ring were also identified. In general, these particles were flake-like in shape and no larger than $2\mu\text{m}$ in diameter. A relatively large particle is shown in Fig. 32a together with its

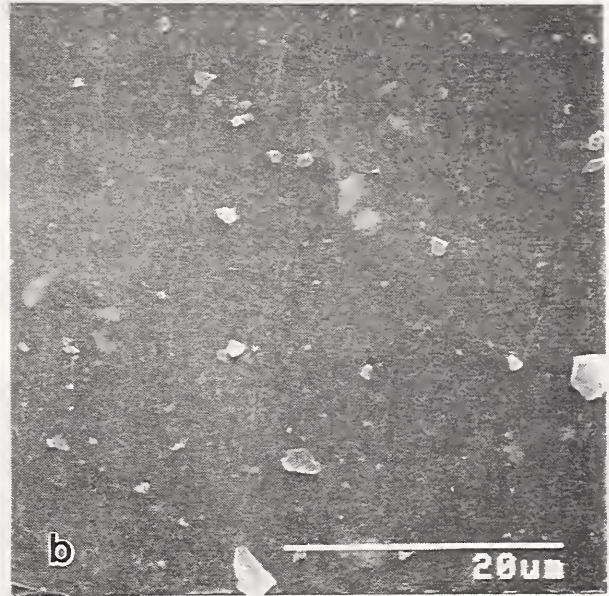
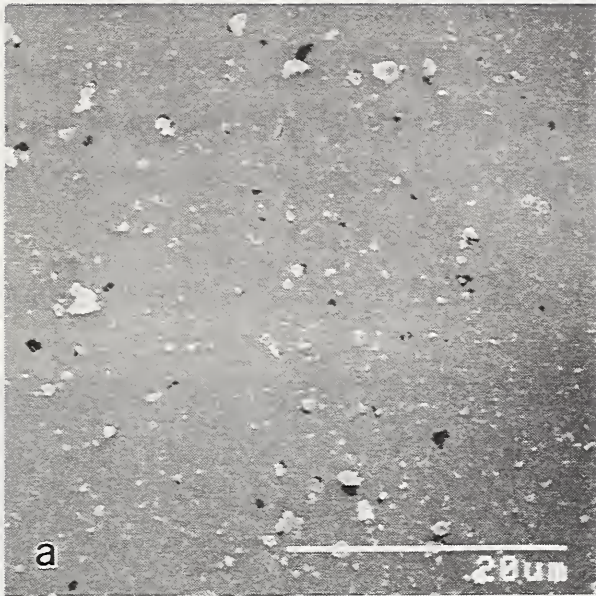

Fig. 30. (a) Debris collected from the outlet side of the contact during unidirectional sliding test with 2 μm quartz particles. (b) Debris collected from the outlet side of the contact during unidirectional sliding test with 10 μm quartz particles.

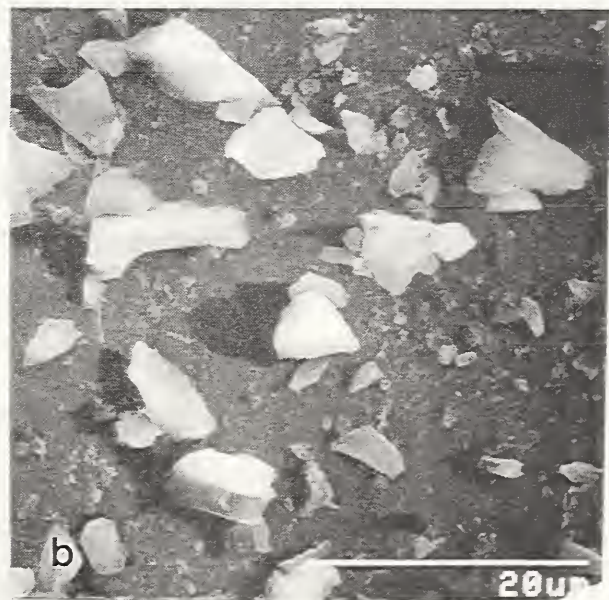
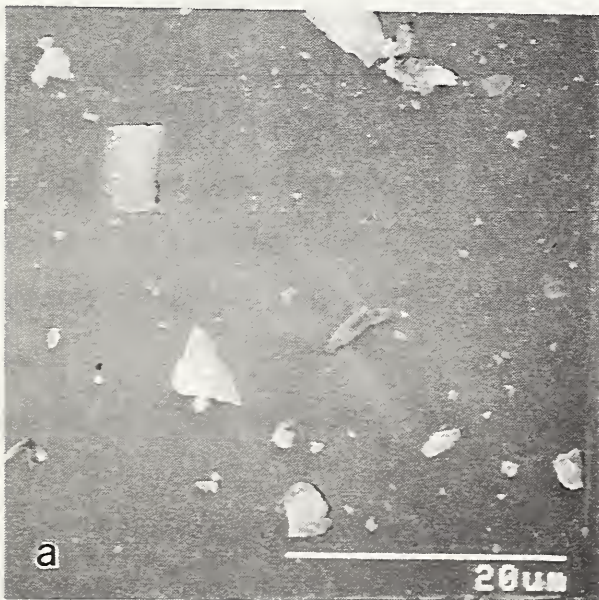

Fig. 31. (a) Unused 2 μm quartz particles. (b) Unused 10 μm particles.

x-ray spectrum in Fig. 32b. The small size of the particles suggests that quartz was not a very effective abrasive with respect to hardened 52100 steel. Consistent with the observation that quartz particles were crushed in the contact, their relatively low strength also limited their ability to produce large chips.

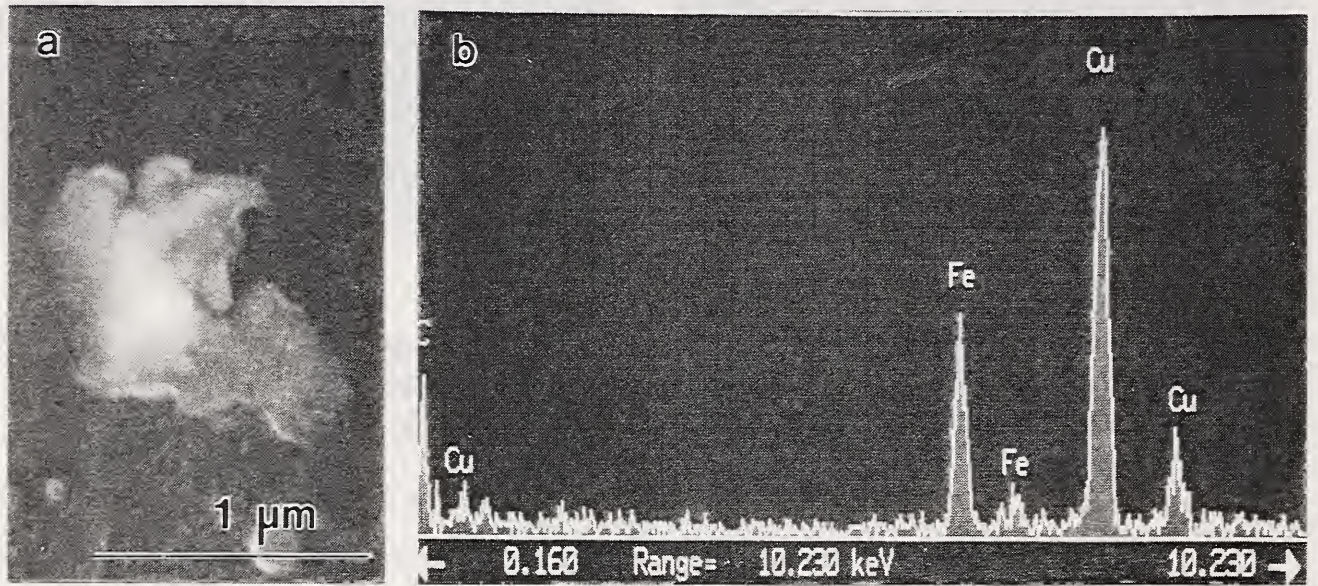

Fig. 32. (a) Metal debris particle. (b) Energy dispersive x-ray spectrum from particle. The Cu peak is from the support and the C peak is from the carbon coating.

4. SUMMARY AND CONCLUSIONS

The following is a summary of the most important results and conclusions. For convenience they are separated into four different subject areas.

Coal-Fuel and Combustion Particle Characteristics

The findings apply to a particular type of coal-fuel, prepared from an Eastern bituminous coal, Kentucky Blue Gem. Beneficiation was by comminution and a fluid agglomeration process. The ash content of the coal was <1% (dry basis). The hardest minerals present at more than trace concentrations were quartz and iron pyrite.

- 1) Analysis of individual fuel particles established that the mineral matter present was mainly embedded in coal particles indicating that coal free mineral particles were efficiently removed during processing.
- 2) Particles emitted in the exhaust of a coal-fueled diesel engine or accumulated in its lubricating oil were found to be of four different types: a) unburned coal-fuel, b) partially burned particles recognized by their porous morphology and often exhibiting a relatively high concentration of mineral related elements in addition to carbon, c) spherical fly ash particles consisting mainly of mineral elements with essentially no detectable carbon, and d) soot particles on the order of 0.1 μm in diameter.

Particle Characteristics and Particle Related Parameters

The effect on wear rate of particle characteristics was evaluated by means of the rotating pin-on-disk test utilizing 52100 steel pins (820 $\text{HK}_{0.2\text{N}}$) and 52100 steel disks (810 $\text{HK}_{0.2\text{N}}$). For some experiments O-2 tool steel disks (730 $\text{HK}_{0.2\text{N}}$) were employed; this did not alter the general conclusions.

1) After break-in, wear rate was constant independent of sliding distance. This was found to hold true: a) for scar sizes in the range 0.3 mm to 1.3 mm; b) provided there was a continued supply of fresh abrasive particles; and c) wear of the disk did not change the contact geometry.

2) In the nominal-particle-size range, 1 μm to 10 μm , wear rate increased exponentially with increasing particle size.

3) For particles harder than the 52100 steel pin (820 $\text{HK}_{0.2\text{N}}$) wear rate increased exponentially with increasing hardness. This is contrary to the often stated finding that wear rate is independent of particle hardness for particles approximately 1.2 times harder than the surface subject to abrasion. The latter observation holds when the particles are supported by a soft counterface and not for a hard counterface, as in these experiments.

4) The influence on wear rate of particle concentration in the lubricant was complex. In general, wear rate increased rapidly with increasing particle concentration to about 2%. At intermediate concentrations the rate of increase was substantially less, but increased again at high concentrations due apparently to fluid rheology effects. It was hypothesized that the number of particles in the contact at a given instant and the ability of particles to enter the contact were controlling variables.

5) Below a certain threshold amount, the quantity of mixture employed in the test had a significant influence on wear rate. Above the threshold, the wear rate was independent of quantity. Below the threshold, wear rate was observed to increase significantly and then decrease as the quantity of mixture was reduced. As in 4) above, the number of available particles and their ability to enter the contact were thought to be controlling factors.

6) Tests conducted on coal-fuel particles, particles remaining after the combustion of coal-fuel, and mineral matter particles extracted from coal during the preparation of coal-fuel exhibited significant differences in wear rate. For example, at a concentration of 10% particles the addition of coal-fuel particles to mineral oil resulted in about a 65% increase in wear rate. Similarly, the combustor particles cause a 6-fold increase while the highly aggressive mineral matter particles result in a 30-fold increase.

7) For Al_2O_3 particles, embedment in the 52100 steel disk was found to result in a significant increase in wear rate. Embedment, if it did occur, had no observable effect in the case of softer quartz and coal-fuel related particles.

Environmental Variables

1) A decrease in the relative humidity of the surrounding air environment resulted in a significant increase in wear rate for quartz particles. A similar effect was observed for combusted coal particles; however, at high particle concentrations the effect diminished substantially.

2) Although the addition of the antiwear additive zinc dialkyldithiophosphate caused a decrease in wear rate when added to mineral oil, with abrasive particles present in the oil the additive caused an increase in wear rate.

Materials Properties

The rotating pin-on-disk test was employed to compare the wear rate of a number of different materials including metals, ceramics, cermets, and glasses. Particles accumulated in the oil filter of a diesel engine operating on coal-fuel and mineral matter extracted during processing of coal-fuel were used in these tests. In general, it was found that materials having a hardness greater than ~10 GPa exhibited

a significantly lower wear rate than materials having a hardness less than ~10 GPa. Aside from this general relationship, no simple functional connection between hardness or other materials property and wear rate was observed.

Effect of Sliding Motion

A block-on-ring test which could be configured for either unidirectional rotational sliding or reciprocating sliding was used to investigate the effect of sliding motion on wear rate. Somewhat higher wear rates were obtained with reciprocating sliding than with unidirectional sliding. In connection with these experiments it was also observed that a small misalignment of the ring which allowed a small gap to open periodically between the ring and block contact resulted in a significant increase in wear rate. The increase was attributed to the improved access of abrasive particles into the contact.

5. ACKNOWLEDGEMENTS

I wish to express my appreciation and thanks to the following for providing various particulate materials used in the experiments: R. L. Mehan, A. W. Giammarise, and C. L. Spiro of General Electric Company; R. M. Kakwani and P. R. Badgley of Adiabatics, Inc.; and D. S. Keller of Otisca Industries, Ltd.

6. REFERENCES

1. L. K. Ives, M. B. Peterson and E. P. Whitenton, "Mechanisms of Galling and Abrasive Wear," in AR&TD Fossil Energy Materials Program Semiannual Progress Report for the Period Ending September 30, 1988, ONRL/FMP-88/2, Oak Ridge National Laboratory, Oak Ridge, TN, January 1989, pp. 445-462.
2. L. K. Ives, M. B. Peterson and E. P. Whitenton, "Mechanisms of Galling and Abrasive Wear," in AR&TD Fossil Energy Materials Program Semiannual

Progress Report for the Period Ending March 31, 1989, ONRL/FMP-89/1, Oak Ridge National Laboratory, Oak Ridge, TN, July, 1989, pp. 455-469.

3. L. K. Ives, M. B. Peterson and E. P. Whitenton, "Mechanisms of Galling and Abrasive Wear," in Fossil Energy Advanced Research and Technology Development Materials Program Semiannual Progress Report for the Period Ending September 30, 1989, ONRL/FMP-89/2, Oak Ridge National Laboratory, Oak Ridge, TN, January, 1990, pp. 447-465.
4. L. K. Ives, "Mechanisms of Galling and Abrasive Wear," in Fossil Energy Advanced Research and Technology Development Materials Program Semiannual Progress Report for the Period Ending September 30, 1990, ONRL/FMP-90/2, Oak Ridge National Laboratory, Oak Ridge, TN, December 1990, pp. 341-352.
5. L. K. Ives, "Mechanisms of Galling and Abrasive Wear," in Fossil Energy Advanced Research and Technology Development Materials Program Semiannual Progress Report for the Period Ending September 30, 1991, ONRL/FMP-91/2, Oak Ridge National Laboratory, Oak Ridge, TN, April 1992, pp. 313-327.
6. L. K. Ives, M. B. Peterson and E. P. Whitenton, "Mechanisms of Galling and Abrasive Wear," in Proceedings of the Fourth Annual Conference on Fossil Energy Materials, Oak Ridge National Laboratory, Oak Ridge, TN, August 1990, Conf. 900546, ONRL/FMP-90/1, pp. 417-426.
7. L. K. Ives, "Wear by Coal-Fueled Diesel Engine Particles," in Proceedings of the Fifth Annual Conference on Fossil Energy Materials, Oak Ridge, TN, September 1991, Conf. 9105184, ORNL/FMP-91/1, pp. 367-376.

8. L. K. Ives, "Abrasive Wear by Coal-Fueled Engine Particles," Proceedings Corrosion-Erosion-Wear of Materials at Elevated Temperatures, A. V. Levy, ed., NACE, Houston, TX, 1991, pp. 29-1 thru 29-20.
9. L. K. Ives, Abrasive Wear By Coal-Fueled Diesel Engine and Related Particles, National Institute of Standards and Technology Internal Report, NISTIR 4811, September 1992.
10. B. D. Hsu, "Progress on the Investigation of Coal-Water Slurry Fuel Combustion in a Medium Speed Diesel Engine: Part 1 - Ignition Studies," Journal of Engineering for Gas Turbines and Power, 110, 1988, pp. 415-422.
11. S. E. Nydick, F. Porchet, and H. A. Steiger, Continued Development of a Coal/Water Slurry-Fired Slow-Speed Diesel Engine: a Review of Recent Test Results, J. Engng. for Gas Turbines and Power, 109 (1987) pp. 465-476.
12. R. M. Kakwani, R. Kamo, R. G. Cutlip, and W. C. Smith, "Combustion Characteristics of Dry-Coal-Powder-Fueled Adiabatic Diesel Engine, Coal-Fueled Diesel Engines, ICE-Vol. 7, ASME, New York, NY, 1989, pp. 27-34.
13. A. K. Rao, R. P. Wilson, E. N. Balles, R. A. Mayville, M. H. McMillian, and J. A. Kimberley, "Cooper-Bessemer Coal-Fueled Engine System—Progress Report," ASME Journal of Engineering for Gas Turbines and Power 111 1989, pp. 498-506.
14. P. L. Flynn, G. L. Leonard and R. L. Mehan, "Component Wear in Coal-Fueled Diesel Engines," ASME Journal of Engineering for Gas Turbines and Power 111 1989, pp. 521-529.

15. T. W. Ryan III and J. A. Schwalb, "Wear Mechanism and Wear Prevention in Coal-Fueled Diesel Engines," in Proceedings of the Eighth Annual Coal-Fueled Heat Engines and Gas Stream Cleanup Systems Contractors Review Meeting, ed. H. A. Webb, R. C. Bedick, D. W. Geiling, and D. C. Cicero, DOE/METC-91/6122, pp. 237-246.
16. "Practice for Ranking Resistance of Materials to Sliding Wear Using Block-On-Ring Wear Test," G77-91, 1991 Annual Book of ASTM Standards, Vol. 03.02, ASTM, Philadelphia, PA, 1991, pp. 306-317.
17. D. V. Keller, Jr., "Separation of Mineral Matter from Pittsburgh Coal by Wet Milling," in Mineral Matter and Ash in Coal, K. S. Vorres, Ed., American Chemical Society, Washington, D.C., 1986, pp. 473-484.
18. R. C. Streeter, "Evaluation of the Effect of Coal Cleaning on Fugitive Elements—Phase IV Identification of Mineral Forms in Coal," BCR Report L-1551, (1986), Available from NTIS Springfield, VA.
19. R. L. Mehan, "The Wear of Selected Materials in Mineral Oil Containing a Solid Contaminant," Wear 124, (1988) pp. 65-85.
20. M. M. Khrushov, "Principles of Abrasive Wear," Wear 28 (1974) pp. 69-88.
21. R. C. D. Richardson, "The Wear of Metals by Relatively Soft Abrasives," Wear 11 (1968) pp. 245-275.
22. A. Misra and I. Finnie, "An Experimental Study of Three-Body Abrasive Wear," Wear of Materials - 1981, S. K. Rhee, A. W. Ruff and K. C. Ludema, eds., ASME, NY (1981) pp. 426-431.

23. J. L. Xuan, I. T. Hong and E. C. Fitch, "Hardness Effect on Three-Body Abrasive Wear Under Fluid Film Lubrication," *ASME Journal of Tribology* 111 (1989) pp. 35-40.
24. F. Hirano and S. Yamamoto, "Four-Ball Test on Lubricating Oils Containing Solid Particles," *Wear* 2 (1958/59) pp. 349-363.
25. J. Larsen-Basse, "Influence of Atmospheric Humidity on Abrasive Wear—I. 3-Body Abrasion," *Wear* 31 (1975) p. 373-379.
26. L. K. Ives and M. B. Peterson "Effect of Solid Additives on Wear by Greases Containing Abrasive Particles," Wear of Materials - 1985, K. C. Ludema, ed., ASME, NY, 1985, pp. 355-363.
27. S. Malkin, Grinding Technology, Ellis Horwood, Ltd., 1989, p. 213.
28. T. E. Fischer, "Friction and Wear of Ceramics," *Scripta Met.* 24 (1990) pp. 833-838.
29. S. F. Wayne, J. G. Baldoni and S.-T. Buljan, "Abrasion and Erosion of WC-Co With Controlled Microstructures," *Tribology Transactions* 33 (1990) pp. 611-617.
30. J. Larsen-Basse, "Resistance of Cemented Carbides to Sliding Abrasion: Role of Binder Metal," Science of Hard Materials, R. K. Viswanadham, D. J. Rowcliffe, and J. Gurland, eds. Plenum Press, NY, 1981, pp. 797-813.

DISTRIBUTION

ARGONNE NATIONAL LABORATORY
9700 S. Cass Avenue
Argonne, IL 60439
W. A. Ellingson

AVCO RESEARCH LABORATORY
2385 Revere Beach Parkway
Everett, MA 02149
R. J. Pollina

BABCOCK & WILCOX
1562 Beeson St.
Alliance, OH 44601
T. I. Johnson

BABCOCK & WILCOX
Domestic Fossil Operations
20 South Van Buren Avenue,
Barberton, OH 44023
M. Gold

BATTELLE-COLUMBUS LABORATORIES
505 King Avenue
Columbus, OH 43201
I. G. Wright

BRITISH COAL CORPORATION
Coal Research Establishment
Stoke Orchard, Cheltenham
Gloucestershire, England GL52 4RZ
J. Oakey

CANADA CENTER FOR MINERAL & ENERGY
TECHNOLOGY
568 Booth Street
Ottawa, Ontario
Canada K1A 0G1
R. Winston Revie
Mahi Sahoo

ELECTRIC POWER RESEARCH INSTITUTE
P.O. Box 10412
3412 Hillview Avenue
Palo Alto, CA 94303
W. T. Bakker
J. Stringer

EUROPEAN COMMUNITIES JOINT RESEARCH
CENTRE
Petten Establishment
P.O. Box 2
1755 ZG Petten
The Netherlands
M. Van de Voorde

GAS RESEARCH INSTITUTE
8600 West Bryn Mawr Avenue
Chicago, IL 60631
H. S. Meyer

LAWRENCE LIVERMORE LABORATORY
P.O. Box 808, L-325
Livermore, CA 94550
W. A. Steele

MOBIL RESEARCH & DEVELOPMENT
CORPORATION
P. O. Box 1026
Princeton, NJ 08540
R. C. Searles

NATIONAL INSTITUTE OF STANDARDS AND
TECHNOLOGY
Materials Building
Gaithersburg, MD 20899
S. J. Dapkunas
L. K. Ives

NATIONAL MATERIALS ADVISORY BOARD
National Research Council
2101 Constitution Avenue
Washington, DC 20418
K. M. Zwilsky

NEW ENERGY AND INDUSTRIAL TECHNOLOGY
DEVELOPMENT ORGANIZATION
Sunshine 60 Bldg.
P.O. Box 1151
1-1, Higashi-Ikebukuro 3-chrome
Toshima-Ku
Tokyo, 170
Japan
H. Narita
S. Ueda

OAK RIDGE NATIONAL LABORATORY
P.O. Box 2008
Oak Ridge, TN 37831
P. J. Blau
P. T. Carlson
N. C. Cole
R. R. Judkins
J. R. Keiser
R. A. Lawson (8 copies)
P. T. Thornton

SHELL DEVELOPMENT COMPANY
P. O. Box 1380
Houston, TX 77251-1380
L. W. R. Dicks

TENNESSEE VALLEY AUTHORITY
Energy Demonstration & Technology
MR 2N58A
Chattanooga, TN 37402-2801
C. M. Huang

UNIVERSITY OF NOTRE DAME
Department of Materials Science and Engineering
P.O. Box E
Notre Dame, IN 46556
T. H. Kosel

WESTERN RESEARCH INSTITUTE
365 N. 9th Street
P.O. Box 3395
University Station
Laramie, WY 82071
V. K. Sethi

WESTINGHOUSE HANFORD COMPANY
P.O. Box 1970
W/A-65
Richland, WA 99352
R. N. Johnson

DOE
DOE OAK RIDGE OPERATIONS
P. O. Box 2001
Oak Ridge, TN 37831
Assistant Manager for Energy Research and Development

DOE
DOE OAK RIDGE OPERATIONS
P. O. Box 2008
Building 4500N, MS 6269
Oak Ridge, TN 37831
E. E. Hoffman

DOE
OFFICE OF BASIC ENERGY SCIENCES
Materials Sciences Division
ER-131, GTN
Washington, DC 20545
J. B. Darby

DOE
OFFICE OF FOSSIL ENERGY
Washington, DC 20545
J. P. Carr (FE-72) GTN

DOE
MORGANTOWN ENERGY TECHNOLOGY CENTER
P.O. Box 880
Morgantown, WV 26505
R. A. Bajura
R. C. Bedick
D. C. Cicero
F. W. Crouse, Jr.
N. T. Holcombe
W. J. Huber
M. J. Mayfield
J. E. Notestein
J. S. Wilson

DOE
PITTSBURGH ENERGY TECHNOLOGY CENTER
P.O. Box 10940
Pittsburgh, PA 15236
A. L. Baldwin
G. V. McGurl
R. Santore
T. M. Torkos

DOE
OFFICE OF SCIENTIFIC AND TECHNICAL
INFORMATION
P. O. Box 62
Oak Ridge, TN 37831
For distribution by microfiche as shown in DOE/TIC-4500,
Distribution Category:
UC-114 (Coal Based Materials and Components)

